



Instruction Manual



EL-FLOW[®] Select series **Thermal Mass Flow Meters and Controllers**

Doc. no.: 9.17.099 rev. M Date: 01-09-2022



ATTENTION

**Please read this document carefully before installing and operating the product.
Not following the guidelines could result in personal injury and/or damage to the equipment.**



Copyright

© 2022 Bronkhorst High-Tech B.V.

All rights reserved. No part of this publication may be reproduced, distributed, or transmitted in any form or by any means, without the prior written permission of the publisher.

Disclaimer

This document has been reviewed and is believed to be accurate. Bronkhorst High-Tech B.V. does not assume liability for errors, inaccuracies or absence of information. The material in this document merely serves information and illustration purposes; no rights can be derived from its contents.

Bronkhorst High-Tech B.V. reserves the right to modify or improve its products and documentation without prior notice. Device specifications and the contents of the package may deviate from what is stated in this document.

Symbols in this document



Important information. Disregarding this information could increase the risk of damage to the equipment, or the risk of personal injuries.



Tips, useful information, attention points. This will facilitate the use of the instrument and/or contribute to its optimal performance.



Additional information available in the referenced documentation, on the indicated website(s) or from your Bronkhorst representative.

Receipt of equipment

Check the outside packaging box for damage incurred during shipment. If the box is damaged, the local carrier must be notified at once regarding his liability. At the same time a report should be submitted to your Bronkhorst representative.

Carefully remove the equipment from the box. Verify that the contents of the package was not damaged during shipment. Should the equipment be damaged, the local carrier must be notified at once regarding his liability. At the same time a report should be submitted to your Bronkhorst representative.



- *Check the packing list to ensure that you received all items included in the scope of delivery*
- *Do not discard spare or replacement parts with the packaging material*

Refer to [Removal and return instructions](#) about return shipment procedures.

Equipment storage

- The equipment should be stored in its original package in a climate controlled storage location.
- Care should be taken not to subject the equipment to excessive temperatures or humidity.
- See technical specifications (data sheet) for information about required storage conditions.

Warranty

Bronkhorst® products are warranted against defects in material and workmanship for a period of three years from the date of shipment, provided they are used in accordance with the ordering specifications and not subject to abuse or physical damage. Products that do not operate properly during this period may be repaired or replaced at no charge. Repairs are normally warranted for one year or the balance of the original warranty, whichever is the longer.



See also section 9 (Guarantee) of the Conditions of sales:
www.bronkhorst.com/int/about/conditions-of-sales/

The warranty includes all initial and latent defects, random failures, and indeterminable internal causes. It excludes failures and damage caused by the customer, such as contamination, improper electrical hook-up, physical shock etc.

Re-conditioning of products primarily returned for warranty service that is partly or wholly judged non-warranty may be charged for.

Bronkhorst High-Tech B.V. or affiliated company prepays outgoing freight charges when any part of the service is performed under warranty, unless otherwise agreed upon beforehand. The costs of unstamped returns are added to the repair invoice. Import and/or export charges as well as costs of foreign shipping methods and/or carriers are paid by the customer.

General safety precautions

This product is intended for use by qualified personnel who recognize shock hazards and are familiar with the safety precautions required to prevent possible injury. Read the operating information carefully before using the product.

Before operating, make sure the line cord is connected to a properly grounded power receptacle. Inspect the connecting cables for cracks or breaks before each use.

The equipment and accessories must be used in accordance with their specifications and operating instructions, otherwise the safety of the equipment may be impaired.

Opening the equipment is not allowed. There are no user serviceable parts inside. In case of a defect please return the equipment to Bronkhorst High-Tech B.V.

One or more warning signs may be attached to the product. These signs have the following meaning:



General warning; consult the instruction manual for handling instructions



Surface may get hot during operation



Shock hazard; electrical parts inside

To maintain protection from electric shock and fire, replacement components must be obtained from Bronkhorst. Standard fuses, with applicable national safety approvals, may be used if the rating and type are the same. Non-safety related components may be obtained from other suppliers, as long as they are equivalent to the original component. Selected parts should be obtained only through Bronkhorst, to maintain accuracy and functionality of the product. If you are unsure about the suitability of a replacement component, contact your Bronkhorst representative for information.

Table of contents

1	Introduction	7
1.1	Scope of this manual	7
1.2	Intended use	7
1.3	Product description	7
1.4	Calibration	8
1.5	Maintenance	8
1.6	Documentation	9
1.7	Model key	10
1.7.1	EL-FLOW® Select	10
1.7.2	EL-FLOW® Metal Sealed	11
1.8	Sealing material compatibility	12
2	Installation	13
2.1	Functional properties	13
2.2	Operating conditions	13
2.3	Mounting	13
2.4	Piping requirements	14
2.5	Fluid connection	14
2.6	Electrical connection	14
2.7	Fieldbus connection	15
2.7.1	FLOW-BUS	15
2.7.2	Modbus	16
2.7.3	Other fieldbuses	16
2.8	Communication interface	16
2.8.1	RS232 communication	17
2.8.2	Fieldbus communication	18
2.8.3	E-8000 power supply, readout and control	18
2.8.4	BRIGHT readout and control	19
3	Operation	20
3.1	Powering up and powering down	20
3.2	First use	20
3.3	Mass flow measurement and control	20
3.3.1	Changing fluid set	21
3.4	Valve Safe State	22
3.5	Manual controls	22
3.5.1	LED indications	22
3.5.1.1	Interface status	24
3.5.1.2	DeviceNet™ indications	24
3.5.2	Multifunctional switch	25
3.5.2.1	Normal operating functions	25
3.5.2.2	Power-up functions	26
3.5.2.3	Control mode - readout/change	26
3.5.2.4	Network settings - readout/change	27
3.5.3	Rotary switches	28
3.6	Communication	29
3.6.1	Analog operation	30

3.6.2	Digital operation (RS232)	30
3.6.2.1	FlowDDE	30
3.6.2.2	Software (DDE applications)	31
3.6.3	Digital fieldbus operation (RS485)	31
3.7	Adjusting zero point	33
3.7.1	Using multifunctional switch	33
3.7.2	Via digital communication	34
4	Digital parameters	35
4.1	Special parameters	36
4.1.1	Default control mode	37
4.2	Measurement and control	38
4.2.1	Advanced measurement and control	38
4.3	Device identification	39
4.4	Alarms	40
4.5	Counter	42
4.6	Network configuration	43
4.7	Fluid set	45
4.7.1	Advanced fluid set parameters	46
4.8	Master/slave configuration (FLOW-BUS)	47
5	Troubleshooting and service	49
5.1	Errors and warnings	49
5.2	Restoring factory settings	49
5.3	Common issues	50
5.4	Service	52
6	Returns	53
6.1	Removal and return instructions	53
6.2	Disposal (end of lifetime)	53
	Parameter index	55

1 Introduction

1.1 Scope of this manual

This manual covers the **EL-FLOW® Select** (including the EL-FLOW® Metal Sealed) series mass flow meters/controllers for gases. It contains general product information, installation and operating instructions and troubleshooting tips.

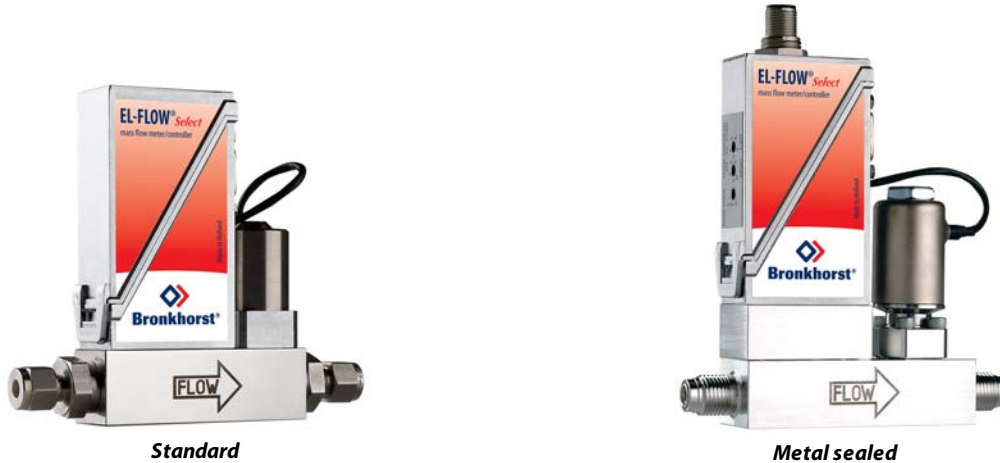

1.2 Intended use

The **EL-FLOW® Select** is designed to accurately measure and/or control gas flow rates in a fluid system using the media and operating conditions (e.g. temperature, pressure) that were specified at ordering time.

The gas(es) in the pressurized system in which the instrument is mounted must be clean and dry. The equipment is suited for general purpose indoor (dry) applications, like laboratories and machine enclosures.

EL-FLOW® Select instruments are suitable for use at temperatures conditions between -10 and +70 °C and a relative humidity of 10 to 90% RH, unless specified otherwise. The instruments have an ingress protection of IP-40, implying that the electronics housing and electrical connection do not offer any protection against moist environments.

EL-FLOW® Metal Sealed instruments are designed for high purity applications.



The wetted materials incorporated in the EL-FLOW® Select are compatible with media and conditions (e.g. pressure, temperature) as specified at ordering time. If you are planning to use the product (including any third party components supplied by Bronkhorst, such as pumps or valves) with other media and/or other conditions, always check the wetted materials (including seals) for compatibility. See the technical specifications of the product and consult third party documentation (if applicable) to check the incorporated materials.

Responsibility for the use of the equipment with regard to its intended use, suitability for the intended application, cleaning and compatibility of process media with the applied materials lies solely with the user.

The user is responsible for taking the necessary safety measures to prevent damage and/or injury while working with the equipment and process media (as described in the associated Material Safety Data Sheets).

Where appropriate, this document recommends or prescribes safety measures to be taken with respect to media usage or working with the described equipment under the specified conditions. However, this does not relieve the user of aforementioned responsibility, not even if such is not explicitly recommended or prescribed in this document.

Bronkhorst High-Tech B.V. cannot be held liable for any damage and/or injury resulting from unintended, improper or unsafe use, or use with other media and/or under other process conditions than specified at ordering time.

See also section [Sealing material compatibility](#).

1.3 Product description

EL-FLOW® Select series Mass Flow Meters/Controllers are based on the thermal bypass measuring principle. The instruments are of modular construction with a 'laboratory style' printed circuit board housing. Control valves can either be integrally or separately mounted, to measure and control gas flows from 0,014...0,7 ml_n/min up to 8...1670 l_n/min N₂-equivalent.

The standard control valves on Bronkhorst® mass flow controllers are suited for max. 64 or 100 bar pressure ratings. These valves are normally closed and available up to Kv-values of 1.5. Normally open valves can also be supplied. Various other valve constructions enable the controlling of flow rates at very low differential pressure or at high pressure (max. 200 or 400 bar).

All models of the **EL-FLOW® Select** series are equipped with a digital printed circuit board, featuring diagnostics, alarm and counter functions, digital communication (RS232) and remotely adjustable control settings. These digital instruments offer great flexibility thanks to the "multibus" concept, whereby the instruments can be equipped with an on-board interface with DeviceNet™, PROFIBUS DP, PROFINET, Modbus, EtherCAT® or FLOW-BUS protocol.

EL-FLOW® Select instruments can be offered with optional Multi Fluid / Multi Range (MF/MR) functionality (to be specified at the moment of ordering). This option offers greater flexibility for user selection of both flow ranges and gas types, maintaining high accuracy and turndown range for measurement and control. Thanks hereto, users of these instruments can rescale their instruments on site, saving time (and money) for mounting and dismounting. For the convenience of the user, Bronkhorst has developed an easy-to-use software tool called FlowTune for changing the configuration of instruments with activated Multi Fluid / Multi Range option.

This document also applies to **EL-FLOW® Metal Sealed** series mass flow meters/controllers. These instruments are characterized by their unique, patented, metal-to-metal sealing construction with excellent resealing capability. Furthermore, the instruments distinguish themselves by a high surface quality and are therefore especially suitable for meeting the semiconductor and solar industry requirements as well as other high purity gas applications. The base blocks of the mass flow meters and controllers have 1/4" face seal male (VCR) connections. **EL-FLOW® Metal Sealed** series are available for ranges from 0.12...6 ml_n/min up to 1...50 l_n/min N₂-equivalent and are suited for max. 64 or 100 bar pressure ratings. The digital features of the **EL-FLOW® Select** series are also applicable for all metal sealed models.

1.4 Calibration

The EL-FLOW® Select has been factory calibrated. Periodical inspection, recalibration or verification of the accuracy may be subject to individual requirements of the user. Whenever necessary, contact your Bronkhorst representative for information and/or making arrangements for recalibration.

Bronkhorst certifies that the instrument meets the rated accuracy. Calibration has been performed using measurement standards traceable to the Dutch Metrology Institute (VSL).



*Unless specified otherwise, **EL-FLOW® Select** instruments are Air or N₂ calibrated. The calibration is converted to the customer's fluid and conditions using a detailed conversion model. This conversion model provides all the fluid data and calculations for the applicable process conditions and is also used for the optional Multi FLuid/Multi Range functionality of the instrument.*

1.5 Maintenance



Inexpertly servicing instruments can lead to serious personal injury and/or damage to the instrument or the system it is used in. Servicing must therefore be performed by trained and qualified personnel. Contact your Bronkhorst representative for information about cleaning and calibration. Bronkhorst has trained staff available.

- The EL-FLOW® Select needs no regular maintenance if operated properly, with clean media, compatible with the wetted materials, avoiding pressure and thermal shocks and vibrations.
- The instrument's fluid path (the wetted parts) may be purged with a clean, dry and inert gas.
- In case of severe contamination, cleaning the wetted parts may be necessary.
- After cleaning the wetted parts, recalibration is recommended.

1.6 Documentation

The EL-FLOW® Select comes with all necessary documentation for basic operation and maintenance. Some parts of this manual refer to other documents, most of which can be downloaded from the Bronkhorst website. Calibration certificates, test certificates and material certificates are included in the scope of delivery or can be provided on request.



The documentation listed in the following table is available on the **EL-FLOW® Select** product pages under www.bronkhorst.com/products :

Type	Document name	Document no.
Brochures	EL-FLOW® Select Brochure	9.60.006
	Metal Sealed Brochure	9.60.013
Manuals	Instruction Manual EL-FLOW® Select (this document)	9.17.099
	Quick Installation Guide EL-FLOW® Select	9.17.098
Technical documentation	Hook-up diagram Analog/RS232	9.16.119
	Hook-up diagram CANopen	9.16.217
	Hook-up diagram DeviceNet™	9.16.122
	Hook-up diagram EtherCAT®	9.16.124
	Hook-up diagram EtherNet/IP	9.16.215
	Hook-up diagram FLOW-BUS	9.16.120
	Hook-up diagram Modbus ASCII / RTU	9.16.123
	Hook-up diagram Modbus TCP	9.16.234
	Hook-up diagram POWERLINK	9.16.237
	Hook-up diagram PROFIBUS DP	9.16.121
	Hook-up diagram PROFINET	9.16.147
	Hook-up diagram custom bus & I/O configurations	9.16.118
	Dimensional drawings	model specific



The documentation listed in the following table can be downloaded from www.bronkhorst.com/downloads :

Type	Document	Document no.
General documentation	EU Declaration of Conformity	9.06.021
	Manual CANopen interface	9.17.131
	Manual DeviceNet™ interface	9.17.026
	Manual EtherCAT® interface	9.17.063
	Manual EtherNet/IP interface	9.17.132
	Manual FLOW-BUS interface	9.17.024
	Manual Modbus interface ASCII / RTU / TCP	9.17.035
	Manual POWERLINK interface	9.17.142
	Manual PROFIBUS DP interface	9.17.025
	Manual PROFINET interface	9.17.095
	Manual RS232 interface	9.17.027

1.7 Model key

The model key on the serial number label contains information about the technical properties of the instrument as ordered. The specific properties can be retrieved with the diagrams below.

1.7.1 EL-FLOW® Select

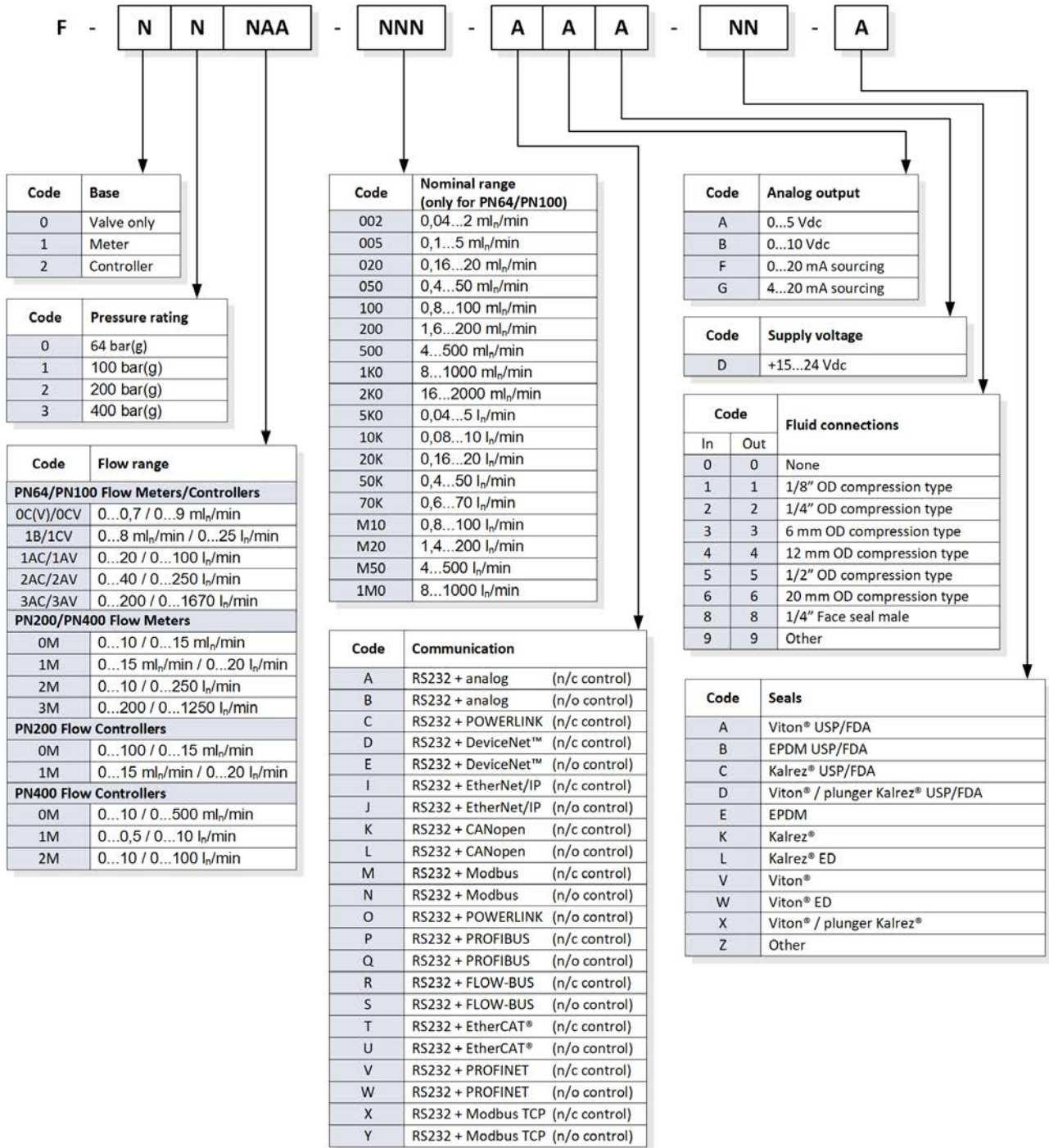

1.7.2 EL-FLOW® Metal Sealed

F - **NNNAA** - **NNN** - **A A A** - **NN** - **A**

Code	Base model
F-111CM	Mass flow meter
F-201CM	Mass flow controller

Code	Nominal range (factory selected)
010	0,2...10 ml _n /min
020	0,16...20 ml _n /min
050	0,4...50 ml _n /min
100	0,8...100 ml _n /min
200	1,6...200 ml _n /min
500	4...500 ml _n /min
1K0	8...1000 ml _n /min
2K0	16...2000 ml _n /min
5K0	0,04...5 l _n /min
10K	0,08...10 l _n /min
20K	0,16...20 l _n /min
40K	0,32...40 l _n /min

Code	Communication
A	RS232 + analog (n/c control)
B	RS232 + analog (n/o control)
C	RS232 + POWERLINK (n/c control)
D	RS232 + DeviceNet™ (n/c control)
E	RS232 + DeviceNet™ (n/o control)
I	RS232 + EtherNet/IP (n/c control)
J	RS232 + EtherNet/IP (n/o control)
K	RS232 + CANopen (n/c control)
L	RS232 + CANopen (n/o control)
M	RS232 + Modbus (n/c control)
N	RS232 + Modbus (n/o control)
O	RS232 + POWERLINK (n/o control)
P	RS232 + PROFIBUS (n/c control)
Q	RS232 + PROFIBUS (n/o control)
R	RS232 + FLOW-BUS (n/c control)
S	RS232 + FLOW-BUS (n/o control)
T	RS232 + EtherCAT® (n/c control)
U	RS232 + EtherCAT® (n/o control)
V	RS232 + PROFINET (n/c control)
W	RS232 + PROFINET (n/o control)
X	RS232 + Modbus TCP (n/c control)
Y	RS232 + Modbus TCP (n/o control)

Code	Analog output
A	0...5 Vdc
B	0...10 Vdc
F	0...20 mA sourcing
G	4...20 mA sourcing

Code	Supply voltage
D	+15...24 Vdc

Code	Fluid connections
88	1/4" Face seal male

Code	Seals
K	Kalrez® (FFKM)

1.8 Sealing material compatibility

EL-FLOW® Select instruments are fitted from factory with internal seals compatible with the gas type(s) as specified at ordering time. Before using other media, always check their compatibility with the applied sealing materials. Check the [model key](#) on the serial number label to see which sealing materials have been incorporated in your specific instrument. When in doubt, do not hesitate to contact your Bronkhorst representative for more information.

The table below lists compatibility with some commonly used gases:

Gas	Sealing material		
	FKM (Viton®)	EPDM	FFKM (Kalrez®)
Air	✓	✓	✓
Ar (Argon)	✓	✓	✓
CH ₄ (Methane)	✓	✗	✓
CO (Carbon monoxide)	✓	✓	✓
CO ₂ (Carbon dioxide)	max 10 bar(g), 50°C	✓	max 10 bar(g), 50°C (ED compound ¹ max 30 bar(g))
C ₂ F ₆ (Freon-116)	✓	✓	✓
C ₂ H ₂ (Acetylene)	✓/✗ ²	✓	✓
C ₂ H ₄ (Ethylene)	max 10 bar(g) ³	max 10 bar(g)	max 10 bar(g)
C ₂ H ₆ (Ethane)	✓	✗	✓
C ₃ H ₆ #2 (Propylene)	max 10 bar(g)	✗	max 58 bar(g) ³
C ₃ H ₈ (Propane)	✓	✗	✓
Cl ₂ (Chlorine)	✓	✗	✓
He (Helium)	✓	✓	✓
H ₂ (Hydrogen)	✓	✓	✓
H ₂ S (Hydrogen sulfide)	✗	✓	✓
Kr (Krypton)	✓	✓	✓
NF ₃ (Nitrogen trifluoride)	✗	✗	✓
NH ₃ (Ammonia)	✗	✓	✓
NO (Nitric oxide)	✗	✗	✓
N ₂ (Nitrogen)	✓	✓	✓
N ₂ O (Nitrous oxide)	max 20 bar(g), 50°C	✓	✓
O ₂ (Oxygen)	✓	✓	✓
SF ₆ (Sulfur hexafluoride)	✗	✓	✓
SiH ₄ (Silane)	✓/✗ ²	✗	✓
Xe (Xenon)	✓	✓	✓

1) ED: Explosive Decompression resistant

2) Only O-ring seals, not suitable for control valve plunger

3) For higher pressures ED compounds are used



- Always make sure that the applied process gases or mixtures thereof are compatible with the applied sealing materials.
- Do not exceed the specified maximum operating pressure and temperature. Using the instrument outside the specified operating limits might lead to serious damage and dangerous situations.
- The gas(es) used in the fluid system in which the instrument is mounted should be clean and dry.

2 Installation

2.1 Functional properties

Before installing the **EL-FLOW® Select**, check the serial number label to see if the functional properties match your requirements:

- Flow rate
- Media to be used in the instrument
- Upstream and downstream pressure(s)
- Operating temperature
- Valve type (N.C. - Normally Closed / N.O. - Normally Open)
- Input and output signal



2.2 Operating conditions

Test pressure



Bronkhorst® instruments are pressure tested to at least 1.5 times the specified operating pressure and outboard leak tested to at least $2 * 10^{-9}$ mbar l/s Helium.

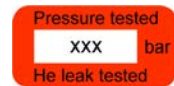

- The test pressure is stated on a red label on the device; if this label is missing or if the test pressure is insufficient, the device must not be used and should be returned to the factory.
- Before installation, make sure that the pressure rating is within the limits of the normal process conditions and that the tested pressure is in accordance with the safety factor of your application.
- Disassembling and/or replacing fluid system related parts of the device will invalidate the test pressure and leak test specification.

Rapid gas decompression / explosive decompression



For instruments used above 10 bar (g):
Bronkhorst recommends a maximum decompression rate of 70 bar/min, according to NACE TM0297.
Exceeding this rate can have negative influence on the lifetime of the sealing materials.

Ambient conditions



Make sure that process gases do not condensate in the instrument due to (changing) ambient conditions, as this may seriously harm the instrument's functionality! Do not use moist air as process gas at low temperatures.

2.3 Mounting



For optimal performance, observe the following guidelines:

- Preferably, mount the EL-FLOW® Select in an upright position, especially if the operating pressure is higher than 10 bar.
- If the instrument is mounted in a position where the flow is directed upwards or downwards, [adjusting the zero point](#) is recommended.
- Avoid installation in close proximity of mechanical vibration and/or heat sources.
- Use the equipment in an environment with a stable ambient pressure and temperature.



For stable fixation, the bottom of the instrument base is fitted with threaded mounting holes. Consult the [dimensional drawing](#) for the exact size and locations.

2.4 Piping requirements



- For reliable performance, make sure the fluid stream is uncontaminated. If necessary, use an inlet filter to ensure a moisture, oil and particle free gas stream. Select a filter with a surface area and pore size that minimize the pressure drop.
- If back flow could occur, the use of a check valve is also recommended.



- Use piping or tubing that is suitable for the operating conditions of the application (media, maximum temperature, maximum operating pressure).
- Do not install small diameter piping/tubing on high flow rates and avoid abrupt angles or other disturbances within a distance of 10 times the (inside) pipe diameter from the inlet or outlet of the device.
- Do not install pressure regulators within a distance of 25 times the (inside) pipe diameter from a controlling instrument.

2.5 Fluid connection

Install the **EL-FLOW® Select** meter/controller in the line, in accordance with the direction of the FLOW arrow on the body of the instrument. Tighten connections according to the instructions of the supplier of the fittings. The use of Swagelok RS-type stainless steel adapters is recommended, in combination with Bronkhorst® elastomer O-rings.

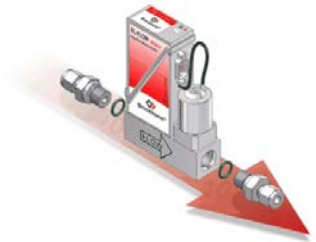

Check the fluid system for leak tightness after any modification and before applying full operating pressure, especially when using hazardous media (e.g. toxic or flammable).

2.6 Electrical connection

Electrical connections must be made with standard cables or according to the applicable hook-up diagram. The factory installed 9-pin D-sub settings are indicated in the hook-up diagram. Make sure that the power supply is suitable for the power ratings as indicated in the hook-up diagram and that double or reinforced insulation is used for the power supply.

EL-FLOW® Select instruments are powered with 15...24 Vdc, depending on the fieldbus system (if applicable).



To prevent damage as a result of reversed polarity, the use of a 2A fuse in the direct +Us line is recommended.



Always turn off electrical power before connecting or disconnecting equipment electrically.



In order to be able to comply with all applicable guidelines and regulations, it is essential that electrical connections be made by or under supervision of a qualified electrician.



- The equipment described in this document contains electronic components that are susceptible to **electrostatic discharge**.
- When working on the electrical installation, take appropriate measures to prevent damage as a result of electrostatic discharge.



The **CE mark** on the equipment indicates that it complies with requirements imposed by the European Union, including **electromagnetic compatibility (EMC)**.

EMC can only be guaranteed by applying appropriate cables and connectors or gland assemblies:

- Cable wire diameters must be sufficient to carry the supply current and minimize voltage loss.
- When connecting the product to other devices, ensure that the integrity of the shielding remains uncompromised; use shielded cables and connectors where possible and/or required.
- Preferably use the supplied cables (if applicable) to make electrical (signal) connections to and between the supplied components. These cables are shielded, have the required wire diameter, and loose ends (if applicable) are marked to facilitate correct connection.

If not all requirements for proper shielding can be met (for example, because a component is not equipped with shielded connectors), take the following measures to ensure the best possible shielding:

- Keep cable lengths at a minimum.
- Route cables as closely as possible alongside metal structures or components.
- Ensure all electrical components are grounded to earth.

When in doubt about the shielding of your cabling and/or electrical connections, contact your Bronkhorst representative.



Always turn off electrical power before connecting or disconnecting equipment electrically.

2.7 Fieldbus connection

If the instrument is provided with a dedicated fieldbus interface, it can be operated digitally in a fieldbus system, using RS485 communication. In FLOW-BUS, Modbus and DeviceNet™ systems, the fieldbus connector can also be used to power the instrument. In other fieldbus systems, the instrument is always powered through the 9-pin D-sub power connector on the side.



Never power the instrument simultaneously from **two different power sources** (e.g. fieldbus and Plug-in Power Supply). Doing so will irreversibly damage the printed circuit board and the instrument will have to be repaired before it can be used.



Always check the total power consumption of your instruments before connecting them to a fieldbus system. Do not exceed the maximum power of the power supply unit.



If you need assistance with setting up a bus configuration, contact your Bronkhorst representative for information.

2.7.1 FLOW-BUS

FLOW-BUS is a Bronkhorst® designed fieldbus, based on RS-485 technology, for digital communication between devices, offering the possibility of host-control by a Windows computer.

Characteristics:

- Baud rate 187500 (default) or 400000 Baud
- +15...24 Vdc supply voltage
- Easy installation and communication with other Bronkhorst® devices
- Automatic node search and bus optimization (gap fixing)
- RS-232 communication ([ProPar](#)) with Windows computer (local host)
- Connection of up to 120 instruments on a single bus
- Maximum bus length: 600 m



Consult **Instruction manual FLOW-BUS interface** (document no. 9.17.024) for more information about setting up a FLOW-BUS network.

2.7.2 Modbus

Modbus is a 3-wire, RS-485-based fieldbus communication system for parameter value exchange. In this system each instrument/device is equipped with a micro-controller for its own dedicated task. The instrument behaves as a slave, which means all communication (instructions and readout) is initiated by a master device on the Modbus system.

Characteristics:

- Baud rate selectable between 9600 and 256000 Baud (default: 19200 Baud)
- +15...24 Vdc supply voltage
- Connection of up to 247 instruments on a single bus
- Supports RTU and ASCII protocols



Consult **Instruction manual Modbus interface** (document no. 9.17.035) for more information about setting up a Modbus network.

2.7.3 Other fieldbuses

For other fieldbuses consult the concerning [fieldbus manual](#).

2.8 Communication interface

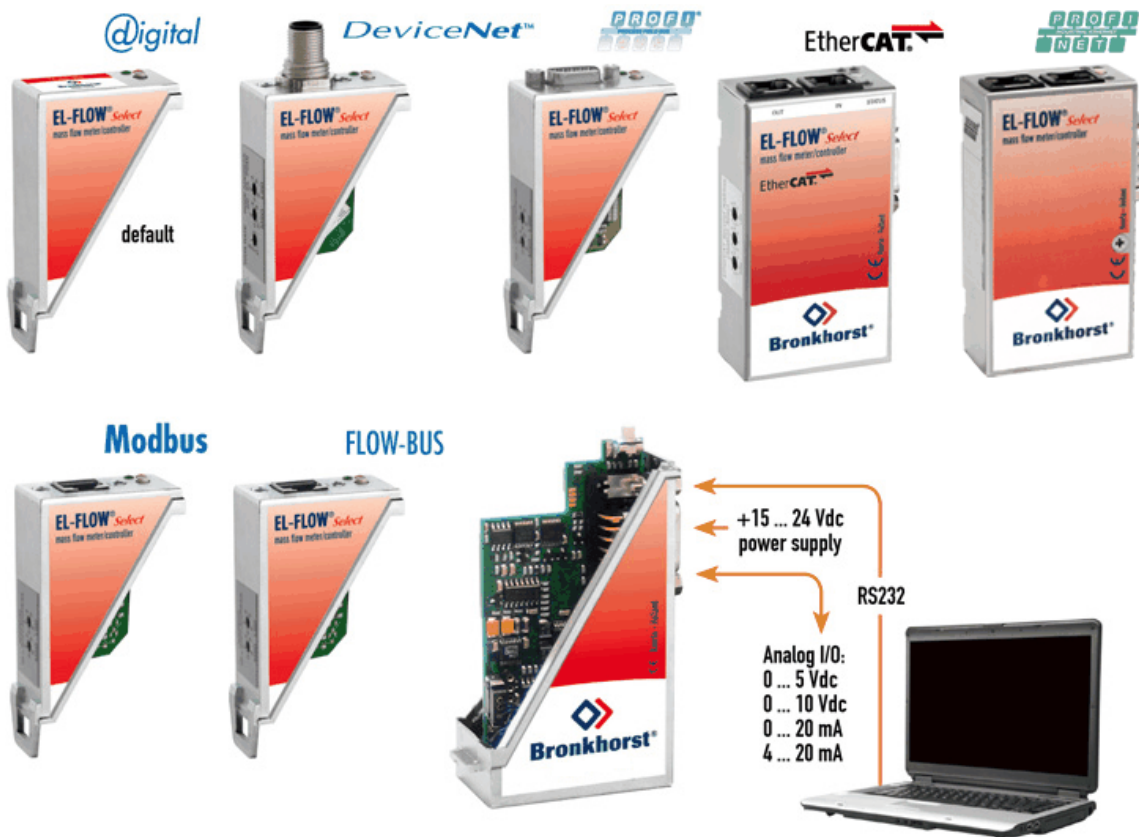

The standard 9-pin D-sub connector provides the following communication interfaces:

- Analog (0...5 Vdc; 0...10 Vdc; 0...20 mA or 4...20 mA)
- Digital RS-232 ([ProPar](#)) or RS-485 (FLOW-BUS or Modbus)

Additionally, the instrument can be provided with one of the following optional digital fieldbus interfaces:

- CANopen
- DeviceNet™
- EtherCAT®
- EtherNet/IP
- FLOW-BUS
- Modbus (ASCII / RTU / TCP)
- POWERLINK
- PROFIBUS DP
- PROFINET

The default communication protocol of the instrument (analog, digital RS-232 or fieldbus) is specified at ordering time.

2.8.1 RS232 communication

Using a Windows computer, the instrument can be monitored and operated via RS-232. For operation, the free Bronkhorst FlowWare tools can be used, providing a comprehensive user interface to the digital instrument functions.

This example uses the following components:

- EL-FLOW® Select
- RS-232 T-part cable (art no. 7.03.366)
- RS-232 to USB converter (art no. 9.09.122)
- Windows computer (for readout and control)
- Plug-in Power Supply (PIPS, art no. 7.03.422)

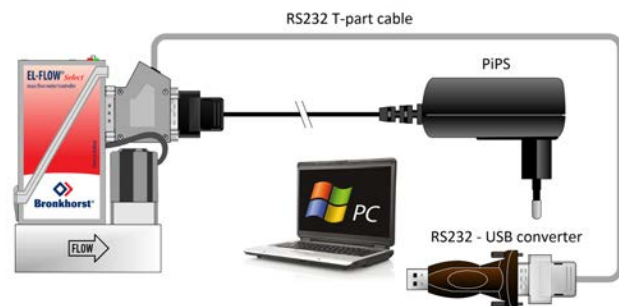

Connect the T-part cable with the 9-pin D-sub connector on the side of the instrument and use the RS-232/USB converter to connect the other end of the cable with a free USB port of the computer.



For communication with a **PLC or other** controlling device, a 9-pin D-sub cable with a loose end (part no. 7.03.004, 7.03.536 or 7.03.537) can be used. Consult the [RS-232 hook-up diagram](#) for wiring details.



For RS-232 communication at baud rates up to 38400 Baud the maximum allowable cable length is 10 m. For higher baud rates, use a maximum cable length of 3 m.



- For more information about communication through the RS-232 interface, consult the [RS-232 manual](#).
- The FlowWare tools and associated documentation can be downloaded from the **Accessories and software** section on the Bronkhorst® product pages (www.bronkhorst.com/products).

2.8.2 Fieldbus communication

The instrument can be connected to a fieldbus system with the optional fieldbus connector on top. At the same time, RS-232 communication with a Windows computer is possible through the 9-pin D-sub connector on the side of the instrument.

This example uses the following components:

- EL-FLOW® Select with DeviceNet™ interface
- DeviceNet™ M12 cable (art no. 7.03.323)
- DeviceNet™ M12 Y adapter (art no. 7.03.319)
- RS-232 cable (art no. 7.03.367)
- RS-232 to USB converter (art no. 9.09.122)
- Windows computer (for readout and control)

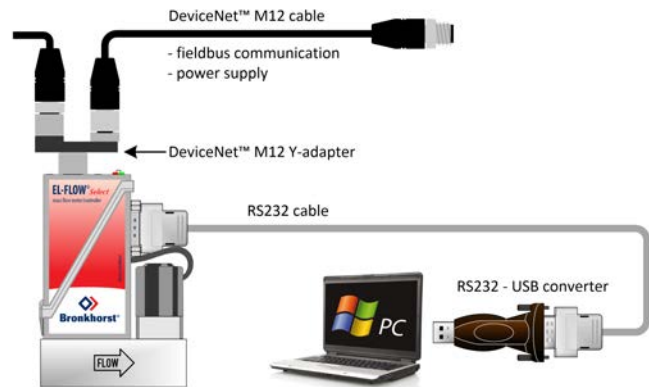

Note that the used fieldbus components in this example are specific to DeviceNet™. For connecting with other fieldbus systems, other cables and adapters are needed.



Always check the total power consumption of your instruments before connecting them to a fieldbus system. Do not exceed the maximum power of the power supply unit.



For all available fieldbus types except PROFIBUS DP, the fieldbus connection on is used to power and operate the instrument. For PROFIBUS DP, the instrument needs to be powered through the 9-pin D-sub connector on the side of the instrument as shown in [RS232 communication](#).



For information about setting up a fieldbus network with Bronkhorst® instruments, consult the according [fieldbus manual](#). If you need assistance with setting up a fieldbus system, contact your Bronkhorst representative for information.

2.8.3 E-8000 power supply, readout and control

Using an E-8000 module, instruments can be powered (100...240 Vac) and operated via RS-232. Most digital parameters and functions are accessible via the display interface and the control buttons.

This example uses the following components:

- 2x EL-FLOW® Select
- 2x RS-232/power supply cable (art no. 7.03.016/7.03.538/7.03.539)
- E-8000 power supply, readout and control module

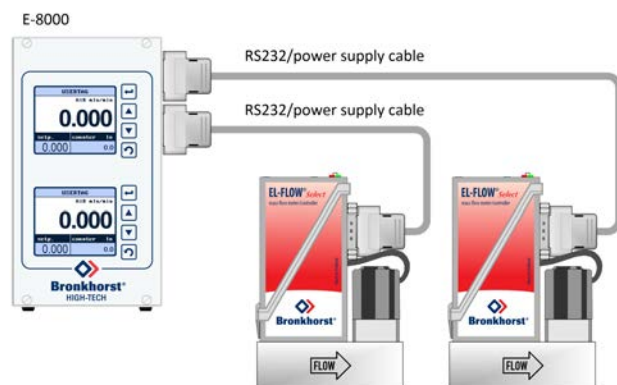

Consult the **E-8000 manual** (document 9.17.076) for more information. This manual can be downloaded from the **Accessories and software** section on the Bronkhorst® product pages (www.bronkhorst.com/products).

2.8.4 BRIGHT readout and control

Most digital parameters and functions are accessible via the display interface and control buttons of a BRIGHT readout and control module (type B1 or B2). When a BRIGHT module is installed, no other RS-232 connection can be established with the instrument.

This example uses the following components:

- EL-FLOW® Select
- BRIGHT readout and control module
- Plug-in Power Supply (PiPS, art no. 7.03.422)



Use the 9-pin D-sub connector on the side of the instrument to plug in the T-part that comes with the BRIGHT module.



Consult the **BRIGHT manual** (document 9.17.048) for more information. This manual can be downloaded from the **Accessories and software** section on the Bronkhorst® product pages (www.bronkhorst.com/products).

3 Operation

After correct installation of the **EL-FLOW® Select** and when all safety precautions have been taken into account, the instrument can be used for measuring and/or controlling mass flow in the system.

3.1 Powering up and powering down



To maintain control of the fluid system and ensure a safe situation, it is recommended to turn on power before applying fluid pressure and to switch off power only after the fluid system is depressurized.



When pressurizing, prevent pressure shocks by gradually bringing the fluid system to the required operating pressure.



For best performance, allow the device to warm up and stabilize for at least 30 minutes before starting measurement and/or control. This may be done with or without media flow.

3.2 First use



In systems for use with corrosive or reactive media, purging for at least 30 minutes with a dry, inert gas (like Nitrogen or Argon) is absolutely necessary before use. After use with corrosive, reactive or hazardous media (e.g. toxic or flammable), purging is also necessary before the fluid system is exposed to air.



If the instrument is mounted in a position with upward or downward flow, adjusting the zero point is advised before using the instrument for the first time. See [Adjusting zero point](#) for background information and instructions.

3.3 Mass flow measurement and control

When powering up, the instrument needs a couple of seconds to start up the electronics. As soon as the start-up sequence has finished (green LED glows continuously), the instrument is ready to measure mass flows, however, optimal accuracy is only reached after warming up (see [Powering up and powering down](#)).

After powering up, the control valve closes (normally open) or stays closed (normally closed). The valve stays closed until the instrument receives a setpoint from the active setpoint source. The internal PID controller then immediately opens the control valve, until the measured flow rate matches the setpoint. It maintains the resulting flow rate until another setpoint is given.

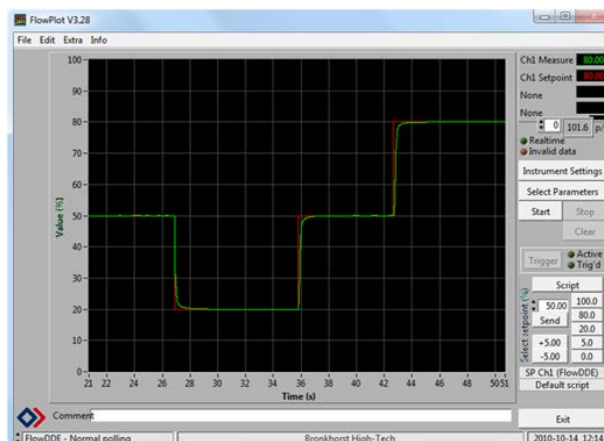

EL-FLOW® Select instruments are most accurate at the specified inlet/outlet pressure, temperature and process gas conditions. However, the instrument will function properly in a wide range of varying conditions. It is strongly advised to use the FlowTune™ software available with the instrument to set the correct process conditions if the actual process conditions differ from the conditions for which the instrument is set (see [Changing fluid set](#)).

Although **EL-FLOW® Select** instruments have excellent temperature stability, the best accuracy is achieved when temperature gradients across the instruments are avoided. Make sure that the gas temperature matches the ambient temperature as good as possible and mount the instruments on a rigid (heat conducting) surface.

EL-FLOW® Select instruments handle pressure shocks in the system well, but are not insensitive to pressure fluctuations. For optimum control stability, provide a stable (pressure controlled) inlet pressure with sufficient buffer volume between the pressure regulator and the instrument and avoid installing multiple instruments or control valves in close proximity to another with small volume piping in between.

3.3.1 Changing fluid set

Optionally, EL-FLOW® Select instruments can provide Multi Fluid/Multi Range functionality (MFMR; available if and as specified at ordering time). If MFMR is enabled, this is indicated in the lower left corner of the serial number label.



MFMR enabled instruments are calibrated ex factory for a number of standard measuring ranges, which can be configured for use with different fluids. Defining fluids and ranges and selecting the active fluid can be done via RS-232 with FlowTune™.

FlowTune™ provides the following key functionality:

- Definition and storage of up to eight different fluids in the instrument
- Storing fluid properties for any gas
- Changing upstream- and/or downstream pressure based on actual process conditions
- Re-ranging the full scale (FS) flow rate within the instrument's supported flow range
- Changing control speed per fluid set for faster or slower (smoother) flow control

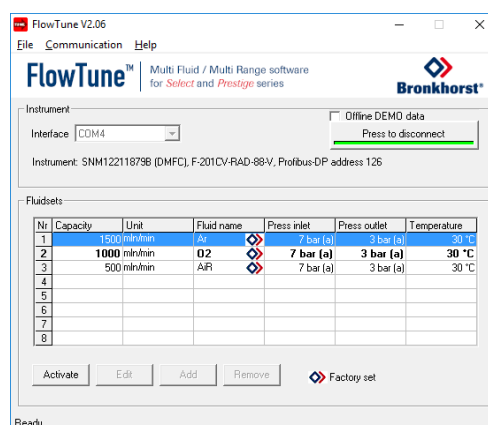

MFMR functionality is available for the full temperature and pressure range of the instrument. FlowTune™ checks the changes for the following limitations:

- Rangeability of the flow sensor for the selected fluid
- Rangeability of the control valve for the selected fluid
- Accuracy indication for the given flow range
- Compatibility of selected gases with the used sealing materials (see [Sealing material compatibility](#))
- Limitations to the operating conditions

After all limitation checks are passed, the entered properties are stored in the instrument, including the required controller settings. When switching to another fluid set, controller settings are automatically adjusted to the new process conditions, so there is no need to change PID controller settings manually.



The FlowTune™ software and the associated documentation can be downloaded from the product pages on the Bronkhorst website: www.bronkhorst.com/products



To connect with FlowTune™, use RS-232 communication via the 9-pin D-sub connector. In case a connection cannot be established, use the power-up functionality of the [multifunctional switch](#) to switch to configuration mode and enable RS-232 communication.

After configuring the required parameters, remember to return the instruments to the original communication mode.

It is advised to use FlowTune™ only in a non-operational environment. FlowTune™ will force the instrument to [Valve Safe State](#) as soon as the connection is made. Be sure to close communication between FlowTune™ and the instrument properly, to restore the normal operating mode.

3.4 Valve Safe State

When a controlling instrument is not powered or cannot communicate with the fieldbus network (if applicable), all electrical valves operated by the instrument (whether integrated or external) automatically return to their default state. The default state is closed for 'normally closed' valves (n/c) and fully open for 'normally open' valves (n/o). Taking into account the typical process conditions under which the instrument is used (such as the processed media and ambient conditions; see also [Intended use](#)), the default state is generally considered safe.

Check the serial number label or the [technical specifications](#) to see which valve type is used on your instrument (if applicable).

3.5 Manual controls

On top of the housing, the instrument is equipped with two LED indicators and a multifunctional switch, which can be used to monitor the instrument visually and start several functions manually.

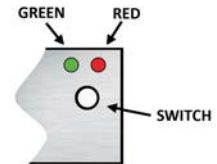

3.5.1 LED indications

The LEDs on top of the instrument indicate the operational state. The meaning of some indications depends on the specific fieldbus interface of the instrument (if installed).

- Mode/MOD Operational mode
- Error/NET Error/warning indication

● Green		
Pattern	Time	Indication
off	continuous	Power off or program not running
on	continuous	Normal operation mode
short flash	0.1 sec on, 2 sec off	No communication, valves are in safe/default state
blink	0.2 sec on, 0.2 sec off	Instrument is busy performing a special function
long flash	2 sec on, 0.1 sec off	Configuration mode; the 9-pin D-sub connector is set for RS-232 communication (ProPar) at 38400 Baud

● Red		
Pattern	Time	Indication
on	continuous	Critical error; the instrument needs servicing before it can be used
short flash	0.1 sec on, 2 sec off	FLOW-BUS Node occupied: re-install instrument PROFIBUS DP No data exchange between master and slave (automatic recovery) Modbus Data is being received or transmitted DeviceNet™ Minor communication error EtherCAT® Instrument is not in OP mode PROFINET No application relation established
blink	0.2 sec on, 0.2 sec off	FLOW-BUS Waiting for communication PROFIBUS DP Not used Modbus Not used DeviceNet™ No bus power EtherCAT® Not used PROFINET Not used
long flash	2 sec on, 0.1 sec off	FLOW-BUS Not used PROFIBUS DP Requested parameter not available Modbus Not used DeviceNet™ Serious communication error; manual intervention needed EtherCAT® Configuration error PROFINET Configuration error (e.g. a requested parameter is not available)

● Green and ● red (alternating)		
Pattern	Time	Indication
slow wink	1 sec on, 1 sec off	Alarm indication; minimum/maximum alarm, power-up alarm, limit reached or batch size reached
normal wink	0.2 sec on, 0.2 sec off	Wink mode; by sending a command to the <i>Wink</i> parameter, the instrument flashes its LEDs, so that it can be located in the physical setup
fast wink	0.1 sec on, 0.1 sec off	Selected action started (after releasing the multifunctional switch)



DeviceNet™ instruments have different LED indications, that replace the standard indications described in this section ([see further](#)).

3.5.1.1 Interface status

On instruments with an Ethernet based fieldbus interface, a third LED (bi-color; green and red) indicates the status of the communication interface:

Pattern	Time	EtherCAT®	PROFINET
● off	continuous	Power off or initializing	Interface not (yet) started
● on, green	continuous	Normal operation	Normal operation, application relation established with I/O controller
● blinking, green	0.2 sec on, 0.2 sec off	Pre-operational	Initializing
● blinking, red	0.2 sec on, 0.2 sec off	Invalid state change	Link status OK, no application relation with I/O controller
● on, red	continuous	n/a	No link
● single flash, red	0.2 sec on, 1 sec off	Invalid configuration	n/a
● double flash, red	0.2 sec on, 0.2 sec off, 0.2 sec on, 1 sec off	Communication timeout (e.g. communication cable disconnected)	n/a

Ethernet indicators

On instruments with an Ethernet based interface, the RJ-45 connection sockets have two integrated LED indicators, with standard Ethernet functionality:

- Amber: Ethernet speed
- Green: Ethernet link/activity

3.5.1.2 DeviceNet™ indications

DeviceNet™ instruments have two bi-color LEDs (green/red) to indicate network and module status. The indications below replace the standard LED indications:

- /● MOD Module status
- /● NET Network status

Module status		
Pattern	Time	Indication
● off	continuous	No power
● on, green	continuous	Normal operation mode
● blinking, green	0.5 sec on, 0.5 sec off	Device is in standby mode or configuration is missing, incomplete or incorrect
●/● alternating	0.5 sec green, 0.5 sec red	Self test mode
● on, red	continuous	Critical error; the instrument needs servicing before it can be used

Network status		
Pattern	Time	Indication
● off	continuous	Power off or offline
● on, green	continuous	Online , connected, link OK
● blinking, green	0.5 sec on, 0.5 sec off	Online, not connected; the instrument is online but has no connections to other nodes or is not allocated to a master
● blinking, red	0.5 sec on, 0.5 sec off	Connection timed out
● on, red	continuous	Critical link failure; the device cannot connect to the network

3.5.2 Multifunctional switch

Some special instrument functions can be started manually using the multifunctional switch near the indication LEDs. These functions are available in analog as well as in digital operation mode.

3.5.2.1 Normal operating functions

- In order to access these functions, press and hold the switch while the instrument is in normal operation mode (green LED lit continuously).
- As long as the switch is held, the LEDs show a repeating sequence of patterns, where each pattern indicates a function.
- All patterns in this sequence are continuous.
- Each pattern is shown for a number of seconds; in the table below, the column labeled *Hold time* indicates the time frame during which a pattern is shown.
- To start a function, release the switch when the LEDs show the pattern of the required function.



● (green)	● (red)	Hold time	Function
off	off	0...1 sec	No action
off	off	1...4 sec	1. In case of a min/max alarm: reset alarm 2. FLOW-BUS: Auto-install to bus - lets instrument obtain free node address Note: min/max alarm (if any) has to be reset before auto install can be performed.
off	on	4...8 sec	Reset instrument; clear all warnings and error messages and restart the instrument
on	off	8...12 sec	Auto-zero; re-adjust the zero-point of the instrument (flow meters/controllers only)
on	on	12...16 sec	Enable FLASH mode for firmware update: <ul style="list-style-type: none"> • the instrument shuts down and both LEDs are switched off • at the next power-up, the instrument will be active again



- See [Adjusting zero point](#) for background information and instructions on how to adjust the zero point of an instrument.
- Do not perform a zeroing procedure before having taken notice of the instructions.

3.5.2.2 Power-up functions





- In order to access these functions, press and hold the switch while powering up the instrument.
- As long as the switch is held, the LEDs show a repeating sequence of patterns, where each pattern indicates a function.
- All patterns in this sequence are flashing (0.2 sec on, 0.2 sec off).
- Each pattern is shown for a number of seconds; in the table below, the column labeled *Hold time* indicates the time frame within the sequence during which a pattern is shown.
- To start a function, release the switch when the LEDs show the pattern of the required function.

 (green)	 (red)	Hold time	Function
off	off	0...4 sec	No action
off	on	4...8 sec	Restore factory settings (except communication settings)
on	off	8...12 sec	<ul style="list-style-type: none"> • FLOW-BUS: auto install to bus; let the instrument obtain a free node address from the FLOW-BUS system • Other protocols: no action
on	on	12...16 sec	Activate or deactivate configuration mode <ul style="list-style-type: none"> • The 9-pin D-sub connector is set to RS-232 communication (ProPar) at baud rate 38400 • In configuration mode, the green LED blinks (2 seconds on, 0.1 second off) • Deactivate configuration mode by selecting this function again at the next power-up

3.5.2.3 Control mode - readout/change

Reading control mode

- By briefly pressing the switch 2 times within 1 second in normal operation mode, the instrument shows its current control mode with a series of consecutive LED indication patterns.
- The number of flashes corresponds to the current value of parameter *Control Mode* (see [Special parameters](#)).





Step	Pattern	Indication
1	Green  	number of flashes indicates the tens of the parameter value
2	Red  	number of flashes indicates the units of the parameter value

Examples:

- for value 1 (control mode 'Analog input'), the green LED will flash 0 times and the red LED 1 time
- for value 22 (control mode 'Valve Safe State'), the green and red LED will each flash 2 times

Changing control mode

- By briefly pressing the switch 4 times with intervals of up to 1 second in normal operation mode, the instrument enters a state in which the control mode can be changed.
- This is done in 2 steps, each represented by a LED indication pattern (green or red; see table below).
- The number of flashes corresponds to the available values of parameter *Control Mode* (see [Special parameters](#)).
- At the start of each step, the according LEDs starts flashing fast (0.1 second on, 0.1 second off). By pressing and holding the switch, the associated action is started and the flashing slows (0.5 seconds on, 0.5 seconds off).

Step	Pattern	Maximum flash count	Action
1	Green  	2	set tens of parameter value
2	Red  	9	set units of parameter value

To execute a step, follow these instructions:

- Press and hold the switch (flashing slows)
- To select value 0 (zero), release the switch within 1 second, otherwise:
- Count the number of LED flashes
- Release the switch when the required value is reached
- In case you lose count, keep the switch pressed and wait until the flash count reaches its maximum and restarts

On completion of step 1, the instrument automatically advances to step 2. When both steps have been completed, the instrument returns to its normal operation mode.

If the switch is not pressed within 60 seconds after starting a step, all changes are canceled and the instrument returns to its normal operation mode.



Note that this procedure also sets the [default control mode](#) of the instrument (contrary to changing the control mode digitally).

3.5.2.4 Network settings - readout/change

Reading network settings

- By briefly pressing the switch 3 times with intervals of up to 1 second in normal operation mode, the instrument shows its current node address and baud rate with a series of consecutive LED indication patterns:

Step	Pattern	Indication
1	Green 	number of flashes indicates the tens of the node address
2	Red 	number of flashes indicates the units of the node address
3	Green and red (simultaneous) 	number of flashes indicates the baud rate

Examples:

- for node address 35, the green LED will flash 3 times and the red LED 5 times
- for node address 116, the green LED will flash 11 times and the red LED 6 times





On DeviceNet™ the node address is called MAC ID.

The number of flashes for the baud rate indication is associated with the following baud rates:

Number of flashes (index)	Baud rate					
	FLOW-BUS	Modbus (ASCII/RTU)	PROFIBUS DP	CANopen	DeviceNet™	Ethernet based
0			automatically detected			
1	187500	9600	9600	1000000	125000	100000000
2	400000	19200	19200	800000	250000	
3		38400	45450	500000	500000	
4		56000	93750	250000		
5		57600	187500	125000		
6		115200	500000	50000		
7		128000	1500000	20000		
8		256000	3000000	10000		
9			6000000			
10			12000000			

Changing network settings

- By briefly pressing the switch 5 times with intervals of up to 1 second in normal operation mode, the instrument enters a state in which the node address and baud rate can be changed (non-Ethernet based protocols only; for Ethernet based protocols, network parameters are configured by the fieldbus master and cannot be set on the instrument).
- Changing network parameters with the multifunctional switch is done in 3 steps, each represented by a LED indication pattern (see table below).
- At the start of each step, the according LED(s) start(s) flashing fast (0.1 second on, 0.1 second off). By pressing and holding the switch, the associated action is started and the flashing slows (0.5 seconds on, 0.5 seconds off).

Step	Pattern	Maximum flash count	Action
1	Green 	12	set tens of node address
2	Red 	9	set units of node address
3	Green and red (simultaneous) 	10*	set baud rate index (number of flashes)

*) maximum count depends on the supported baud rates of the fieldbus. See the baud rate table above for supported baud rates and associated indexes.

To execute a step, follow these instructions:

- Press and hold the switch (flashing slows)
- To select value 0 (zero), release the switch within 1 second, otherwise:
- Count the number of LED flashes
- Release the switch as soon as the required value is reached
- In case you lose count, keep the switch pressed and wait until the flash count reaches its maximum and restarts

On completion of a step, the instrument automatically advances to the next step. When all required steps have been completed, the instrument returns to its normal operation mode.

If the switch is not pressed within 60 seconds after starting a step, all changes in the previous steps are cancelled and the instrument returns to its normal operation mode.

3.5.3 Rotary switches

If the instrument is equipped with a fieldbus interface, it also has 2 or 3 rotary switches (depending on the specific interface type).

Using the MSD and LSD switches, the required node address of the instrument can be selected, in the range from 1 to 99. MSD (Most Significant Digit) sets the tens, LSD (Least Significant Digit) sets the units; in the image to the right the address is set to 63 (note that the actual appearance and orientation of the switches can differ from the image).

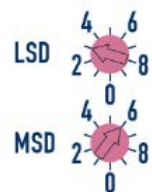

If both switches are set to 0, the node address is set by the according digital parameter (see section [Network configuration](#)).

The switches can be adjusted using a small flat blade screwdriver.



On FLOW-BUS and Modbus instruments, the rotary switches only set the node address for communication through the fieldbus connector (if present). If the instrument is configured for RS-485 communication through the 9-pin D-sub connector (FLOW-BUS or Modbus), use the according digital parameter to set the node address (see section [Network configuration](#)).

DeviceNet™

On DeviceNet™ instruments, the MSD switch provides a smaller range (0-6) and a 'P' option. With this option, the node address is set according to the digital parameters (instead of by setting both switches to 0).

DeviceNet™ instruments have a third switch, for setting the baud rate:

Data rate	Baud rate
1	125000 (default)
2	250000
5	500000
P	Programmable

With the 'P' option, the baud rate is set by the according digital parameter

EtherCAT®

Bronkhorst® instruments with an EtherCAT® interface have 3 rotary switches, with which the *EtherCAT® Second Address* can be set in the range of 0 – 4095 (0xFF). This value is copied to the *Configured Station Alias* register (address 0x0012:0x0013) at instrument start-up.

3.6 Communication

The following table lists the supported communication modes of the EL-FLOW® Select:

Connection	Type	Communication standard	Fieldbus/protocol
9-pin D-sub	Analog	0...5Vdc 0...10Vdc 0...20mA 4...20mA	n/a
	Digital	RS232	ProPar
		RS485	FLOW-BUS Modbus ASCII/RTU
Fieldbus specific	Digital	RS485	FLOW-BUS Modbus ASCII/RTU PROFIBUS DP
		Can	CANopen DeviceNet™
		Ethernet	EtherCAT® Ethernet/IP Modbus TCP/IP POWERLINK PROFINET



The communication standards (analog and digital) and fieldbus interface (if applicable) are specified at ordering time, i.e.:

- In analog mode, the instrument is set to the specified voltage/current range
- The dedicated fieldbus connection only provides the specified fieldbus interface

Simultaneous analog and digital operation

- The instrument can be monitored and operated through the analog and a digital interface simultaneously, but it only accepts a setpoint from one of both (this is called the control mode; see [Special parameters](#) for more information).
- In analog mode, the analog input and output signals are translated to the digital setpoint and measure parameter respectively.

3.6.1 Analog operation

With analog operation the following signals are available:

- output signal: measured value
- input signal: setpoint (controller only)

Setpoints below 2% of the full scale will be interpreted as 0%.

The analog interface type that is installed on the 9-pin D-sub connector can be found in the [model key](#) of the instrument.

3.6.2 Digital operation (RS232)

Digital operation (e.g. via RS-232 or fieldbus) adds extra features to the instrument, such as:

- Direct reading with a readout/control module or host computer
- Diagnostics
- Multi-range functionality
- [Device identification](#)
- Adjustable minimum and maximum alarm limits (see [Alarms](#))
- [\(Batch\) counter](#)



Make sure that the instrument's baud rate matches the baud rate of the master/application, otherwise no communication can be established. See section [Network configuration](#) for changing baud rate, node address and parity setup.

For RS232 communication, the maximum cable length is 10 m for baud rates up to 38400 Baud. For higher baud rates, use cable lengths of maximum 3 m.



- If the 9-pin D-sub connector is set for RS-485 communication, the instrument will not respond to an RS-232 master. In that case, use the [multifunctional switch](#) to enter configuration mode and enable RS-232 communication.
- After configuring the required parameters, follow the same procedure to leave configuration mode and restore the original communication settings (otherwise, configuration mode will remain enabled after the next power-up).



For more information about communication through the RS232 interface, consult the **RS232 manual** (document no. 9.17.027).

3.6.2.1 FlowDDE

Digital Bronkhorst® instruments can be operated via RS-232 using the Bronkhorst® FlowDDE server application. Dynamic Data Exchange (DDE) provides a basic level of inter process communication between Windows applications. Together with a client application, either self-made or with a third party SCADA program, it is possible to create an easy way of data exchange between the flow meter/controller and a Windows application. For instance, a cell in a Microsoft Excel spreadsheet can be linked to the measured value of an instrument; FlowDDE updates the cell automatically when the measured value changes.

FlowDDE uses specific parameter numbers for communicating with the instrument. A DDE parameter number is a unique number in a special FlowDDE instruments/parameter database and not the same as the parameter number from the process on an instrument. FlowDDE translates the node-address and process number to a channel number.

DDE-client applications communicate with the FlowDDE server by using DDE messages. Before messages can be exchanged, a DDE link has to be made. A DDE link consists of three parts: the server, the topic and an item. For separation the characters '|' and '!' may be used, so a DDE link in e.g. Microsoft Excel becomes: Server|Topic!Item.

For standard instrument parameters and the FlowDDE server, these are:

- Server: FlowDDE or FlowDDE2
- Topic: 'C(X)' for channel number X
- Item: 'P(Y)' for parameter number Y

An example of a DDE link in a Microsoft Excel cell is =FlowDDE|'C(1)!P(8)' to read parameter 8 of channel 1.

When not using FlowDDE for communication with the instrument, parameters are addressed by:

- Node address
- Process number
- Parameter number

See section [Digital parameters](#) for more information about instrument parameters.

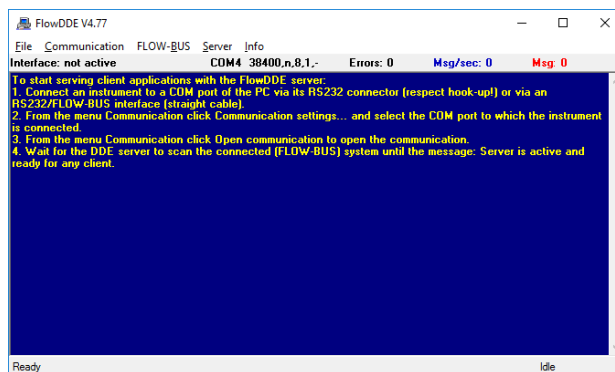

For more information about FlowDDE, including setting up a DDE link, consult the **FlowDDE Manual** (document no. 9.17.067) or the help file in the application.

3.6.2.2 Software (DDE applications)

Examples of free Bronkhorst® DDE client applications: FlowPlot and FlowView. Other software programs supporting DDE are for example MS-Office, LabVIEW, InTouch and Wizcon.

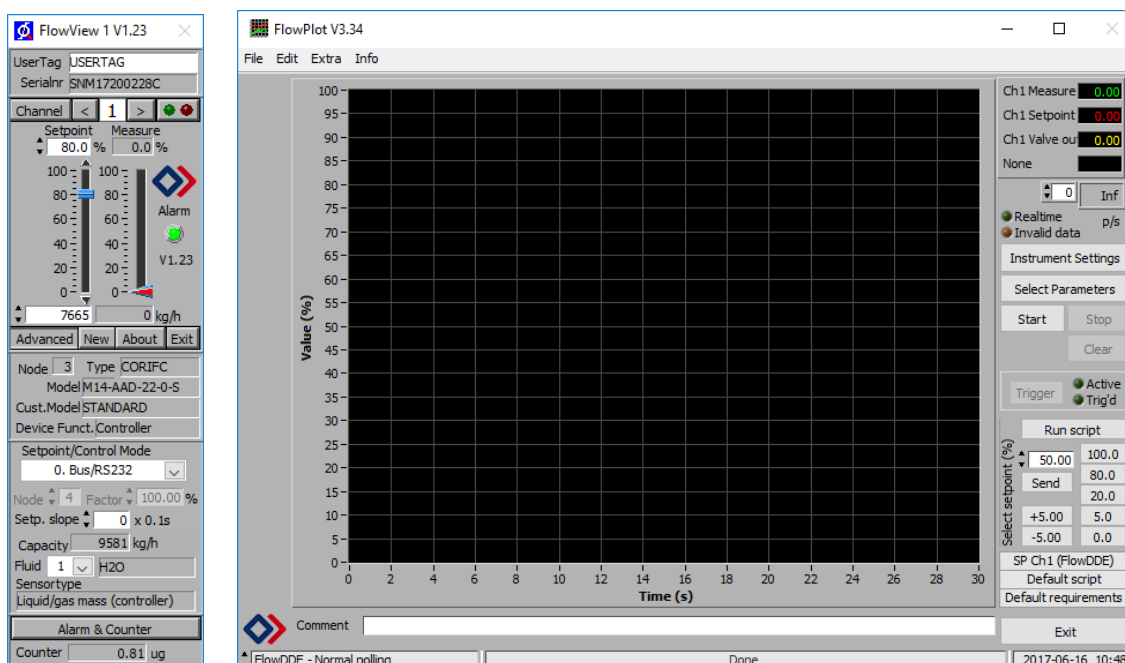

Bronkhorst® software applications 'FlowView' (left) and 'FlowPlot' (right)



FlowDDE and other Bronkhorst® applications are available on the support CD or can be downloaded from the product pages on the Bronkhorst website: www.bronkhorst.com/products

3.6.3 Digital fieldbus operation (RS485)

The following optional fieldbuses are available for **EL-FLOW® Select** instruments. For all mentioned fieldbus systems, except FLOW-BUS, instruments act as slaves on the master/slave bus system. There is no mutual communication between slaves, only between master and slave.

FLOW-BUS

Digital Bronkhorst® instruments can be monitored and operated using the free **FlowWare** software tools for Windows. These tools provide a graphical interface to the [ProPar](#) protocol (used by FLOW-BUS), for monitoring and editing parameter values.

The FlowWare toolkit provides functionality for monitoring and operating digital instruments (FlowSuite, FlowPlot) and selection of the active fluid and configuration of the fieldbus connection (if applicable). For instruments that support the definition and use of multiple fluids, FlowTune™ can be used to define and store fluids in the instrument and select the active fluid.

Digital instrument parameters are made accessible by **FlowDDE**, a Dynamic Data Exchange server (DDE) that handles communication between the instrument and (dedicated) client software in Windows (e.g. FlowPlot). FlowDDE can also be used by other client applications, such as Microsoft Office or custom made software, built with third party development software like LabVIEW or a SCADA platform.



The FlowWare tools and associated documentation can be downloaded from the product pages on the Bronkhorst website: www.bronkhorst.com/products



FlowWare can only be used if the 9-pin D-sub (power) connector is configured for RS232 communication. If necessary, use the power-up functionality of the [multifunctional switch](#) to switch to configuration mode and enable RS232 communication.
After configuring the required parameters, remember to leave configuration mode and restore the original communication settings (otherwise, configuration mode remains enabled after power down).

Modbus

In a Modbus system instruments can be monitored and operated using third party software as a master device, such as LabVIEW, ModScan, or a Modbus PLC.

PROFIBUS-DP

Instruments in a PROFIBUS DP system can be monitored and operated using third party software as a master device, such as TIA Portal (by Siemens).

To configure a device, a so-called GSD file (General Station Description) has to be loaded into the software. The GSD file contains all necessary configuration information to operate the device in a PROFIBUS DP system, including all available operating parameters with their data types.



A GSD file for Bronkhorst® instruments can be downloaded from the product pages on the Bronkhorst website: www.bronkhorst.com/products

DeviceNet™

Instruments in a DeviceNet™ system can be monitored and operated using third party software as a master device, such as TIA Portal (by Siemens).

To configure a device, a so-called EDS file (Electronics Data Sheet) can be loaded into the software. The EDS file contains all necessary configuration information to operate the device in a DeviceNet™ system, including communication and network configuration, and all available operating parameters with their data types.



An EDS file for Bronkhorst® instruments can be downloaded from the product pages on the Bronkhorst website: www.bronkhorst.com/products

EtherCAT®

Instruments in an EtherCAT® system can be monitored and operated using third party software as a master device, such as SyCon® (by Hilscher GmbH).

To configure a device, a so-called ESI file (EtherCAT® Slave Information) can be loaded into the software. The ESI file contains all necessary configuration information to operate the device in a EtherCAT® system, including communication and network configuration, and all available operating parameters with their data types.



An ESI file for Bronkhorst® instruments can be downloaded from the product pages on the Bronkhorst website: www.bronkhorst.com/products

PROFINET

Instruments in a PROFINET system can be monitored and operated using third party software as a master device, such as TIA Portal (by Siemens).

To configure a device, a so-called GSDML file (General Station Description Markup Language) can be loaded into the software. The GSDML file contains all necessary information, in XML format, to operate the device in a PROFINET system, including communication and network configuration, and all available operating parameters with their data types.



A GSDML file for Bronkhorst® instruments can be downloaded from the product pages on the Bronkhorst website: www.bronkhorst.com/products

3.7 Adjusting zero point**Zero-stability**

The zero point of a Bronkhorst® flow meter/controller (the measurement signal that indicates the absence of a flow) is factory adjusted at approximately 20 °C and atmospheric pressure (ambient conditions), with the instrument positioned upright. Under normal circumstances (i.e. at stable process conditions), the zero point will remain stable. However, over time several factors can induce a slight deviation of the measured value from the zero point, causing the instrument to detect a flow when in reality there is none. Readjusting the zero point eliminates this deviation.



- After installation or relocation, always check the zero point.
- If the instrument still detects a (steady) flow while all valves are closed and the fluid system is leak tight, adjusting the zero point is recommended.

Prerequisites

Zeroing an instrument requires that:

- the ambient conditions (temperature, pressure) match those of the operating environment of the instrument.
- the instrument is filled homogeneously and pressurized with the operational media, according to the typical process conditions.
- the instrument has been warmed up sufficiently.
- there is absolutely no flow through the instrument; preferably, this is achieved by closing a valve immediately after the outlet of the instrument (control valve, shut-off valve).



Blocking the flow through the instrument is essential; zeroing an instrument while there is still a flow will lead to measurement errors.

Procedure

The zero point may be re-adjusted digitally (via RS-232 or fieldbus) or manually, using the multifunctional switch. Regardless of the preferred method, once started, the zeroing procedure itself takes approximately 10 seconds to complete (longer if the output signal is unstable)

3.7.1 Using multifunctional switch

To start the autozero function with the multifunctional switch, follow these instructions:

1. Change the setpoint of the instrument to 0 (zero).
2. Press and hold the multifunctional switch. After 4 seconds, the red LED ● lights up; another 4 seconds later the red LED extinguishes and the green LED ● lights up.
3. At that moment (which is after 8 to 12 seconds), release the switch.

The green LED starts to blink fast, indicating that the autozero procedure is in progress. After (successful) completion, the green LED lights up continuously, while the output signal is 0 % (parameter *Measure* = 0).

3.7.2 Via digital communication



FlowPlot and FlowSuite provide an easy way to adjust the zero point of an instrument using RS-232 communication; the Autozero function automatically performs the procedure described here.

To adjust the zero point using digital communication, set parameter values in the following sequence (see section [Digital parameters](#) for more information about instrument parameters):

Sequence #	Parameter	Value	Action
1	Setpoint	0	stop flow (close control valve)
2	Init Reset	64	unlock secured parameters
3	Control Mode	9	enable calibration mode
4	Calibration Mode	0	reset calibration mode
5	Calibration Mode	9	start zeroing

The green LED starts to blink fast, indicating that the zeroing procedure is in progress. On completion, the green LED will glow continuously, while the output signal is 0% (parameter *Measure* = 0). At the same time, parameter *Control Mode* returns to its initial value. If the procedure is successful, parameter *Calibration Mode* changes to 0 (idle). If the procedure fails, *Calibration Mode* changes to 255.



After performing the procedure, remember to set parameter Init Reset to value 0 to lock secured parameters.

4 Digital parameters

This section describes the most commonly used parameters for digital operation of the EL-FLOW® Select. Descriptions are grouped by category in tables as shown below:

Type	Access	Range	FlowDDE	FLOW-BUS	Modbus
[type]	RW 	[x]...[y]	[DDE par]	[Pro]/[Par]	[address]/[register]



In this manual, parameter names are printed in italics (reverted to normal where embedded in italics, like in this tip).

Type

Unsigned char	1 byte unsigned integer (0...255)
Unsigned int	2 byte unsigned integer, MSB first (0...65535)
Unsigned long	4 byte unsigned integer, MSB first (0...4294967295)
Float	4 byte floating point, IEEE 32-bit single precision, MSB first
Unsigned char [x]	x byte text string

Access

R	Parameter value can be read
W	Parameter value can be written
	Parameter is secured and only accepts values if parameter <i>Init Reset</i> is set to 'unlocked' first

Range

Some parameters only accept values within a certain range:

[x]	Minimum value
[y]	Maximum value

FlowDDE

Parameter number within FlowDDE

FLOW-BUS

FLOW-BUS uses the ProPar protocol, where parameters are identified by a unique combination of a process number and a parameter number:

[Pro]	Process number
[Par]	Parameter number



- For more information about setting up a FLOW-BUS network with Bronkhorst® instruments, consult the FLOW-BUS manual (see [Documentation](#)).
- For more information about the ProPar protocol, consult the RS-232 manual (see [Documentation](#)).

Modbus

In the Modbus protocol, parameters are accessed by specifying their unique decimal register number or corresponding PDU address (Protocol Data Unit). The PDU address is the hexadecimal translation of the register number minus 1, e.g. register number 1 corresponds to PDU address 0x0000, register number 11 corresponds to PDU address 0x000A:

[address]	Hexadecimal PDU address
[register]	Decimal register number

Modbus address blocks are two bytes big. Larger data types use up to 8 subsequent address blocks, resulting in a maximum variable length of 16 bytes. Values longer than the maximum length are truncated.



For more detailed information about setting up a Modbus network with Bronkhorst® instruments, consult the Modbus manual (see [Documentation](#)).

Other interface protocols

Parameter descriptions in this document are based on their availability with FLOW-BUS, Modbus or RS-232 (ProPar) communication. Due to limitations in, for example, memory capacity or communication properties, definition files for other fieldbus systems usually do not make all parameters available.



Not all parameters described in this document are necessarily available with all digital interface types. For information about parameter access and availability for Bronkhorst® instruments in a specific fieldbus network, consult the according [fieldbus manual](#).

4.1 Special parameters

Init Reset

Type	Access	Range	FlowDDE	FLOW-BUS	Modbus
Unsigned char	RW	82/64	7	0/10	0x000A/11

Init Reset is used to unlock secured parameters (marked with a ) for writing. It supports the following values:

Value	Description
64	unlocked, secured parameters can be read and written to
82	locked, secured parameters are read-only

At power-up, *Init Reset* is always set to 'Locked' (value 82).

Reset

Type	Access	Range	FlowDDE	FLOW-BUS	Modbus
Unsigned char	R	0..7	114	115/8	0x0E68/3689

This parameter is used to reset the program, counter or alarms.

Value	Description
0	No reset
1	Reset counter
2	Reset alarm
3	Reset counter
4	Reset and disable counter
5	Reset firmware program (soft reset)
6	Reset <i>Alarm info</i> error bit
7	Reset <i>Alarm info</i> warning bit



The Reset parameter may be disabled by Reset Alarm Enable or Reset Counter Enable. Make sure the value is accepted by sending value 0 first.

Wink

Type	Access	Range	FlowDDE	FLOW-BUS	Modbus
Unsigned char [27]	W	0..9*	1	0/0	0x0000/1

Sending any text string value between 1 and 9 to this parameter makes the indication LEDs (if present) blink for a couple of seconds. This can be useful in order to identify a specific device in a large fieldbus network.

*) Modbus only supports value 14592

Control Mode

Type	Access	Range	FlowDDE	FLOW-BUS	Modbus
Unsigned char	RW	0..255	12	115/1	0x0024/37

Control Mode is used to select different control modes of the instrument and determines from which source(s) it accepts a setpoint.

The following modes are available:

Value	List option	Description	Setpoint source
0	Bus/RS232	Normal digital operation	Fieldbus or RS-232
1	Analog input	Normal analog operation	Analog input
2	FLOW-BUS slave	Acting as slave instrument on FLOW-BUS	FLOW-BUS master
3	Valve close	Controller disabled, valve closed	
4	Controller idle	Controller disabled, valve frozen in current position	
7	Setpoint 100%	Setpoint fixed at 100 %	
8	Valve fully open	Controller disabled, valve fully open	
9	Calibration mode	Calibration mode enabled	
10	Analog slave	Acting as slave of other instrument in analog mode	Analog input
12	Setpoint 0%	Setpoint fixed at 0%	
13	FLOW-BUS analog slave	Acting as slave of other instrument on FLOW-BUS, slave factor set by analog input signal	Analog input
18	RS232	Controlling, default/safe state disabled	Fieldbus or RS-232
20	Valve steering	Controller disabled, setpoint redirected to <i>Valve Output</i>	
21	Analog valve steering	Controller disabled, analog input redirected to <i>Valve Output</i>	
22	Valve safe state	Instrument in default/safe state	

- Default value: 0 or 1 (as ordered).
- If *Control mode* is changed to value 0, 1, 9 or 18, the instrument returns to the default value at the next power-up or reset. Other values are persistent.
- *Control mode* 18 prevents the instrument from assuming its [default/safe state](#) in the event of a digital communication failure.
- The column labeled *List option* shows the control modes as used in Bronkhorst® software.

Calibration Mode

Type	Access	Range	FlowDDE	FLOW-BUS	Modbus
Unsigned char	RW 	0, 9, 255	58	1/4	0x0E61/3682

After enabling calibration mode by means of parameter *Control Mode*, this parameter is used to start the autozero function of the flow sensor. The following modes are supported:

Value	Description
0	Idle (no action)
9	Start zeroing
255	Error (result of previous calibration mode)

4.1.1 Default control mode

IO Status

Type	Access	Range	FlowDDE	FLOW-BUS	Modbus
Unsigned char	RW 	0...255	86	114/11	0x0E4B/3660

The instrument is set to accept a setpoint from either an analog or a digital source. Although this setting can be changed with parameter [Control Mode](#), the instrument usually returns to its default control mode at every power-up or reset. The default control mode can be set with parameter *IO Status*; to change it, use the procedures as described below.

Changing from digital operation to analog operation:

1. Set parameter *Init Reset* to 64 (unlocked)
2. Read parameter *IO Status*
3. Add 64 to the read value
4. Write the new value to parameter *IO Status*
5. Set parameter *Init Reset* to 82 (locked)

Changing from analog operation to digital operation:

1. Set parameter *Init Reset* to 64 (unlocked)
2. Read parameter *IO Status*
3. Subtract 64 from the read value
4. Write the new value to parameter *IO Status*
5. Set parameter *Init Reset* to 82 (locked)



The procedures described above do not change the value of parameter Control Mode. To apply the new default control mode, reset or restart the instrument.

4.2 Measurement and control

Measure

Type	Access	Range	FlowDDE	FLOW-BUS	Modbus
Unsigned int	R	0...41942	8	1/0	0x0020/33

This parameter returns a dimensionless representation of the measured flow rate or pressure. Value 32000 corresponds to 100 %, the maximum value corresponds to 131.07 %.

Setpoint

Type	Access	Range	FlowDDE	FLOW-BUS	Modbus
Unsigned int	RW	0...32000	9	1/1	0x0021/34

The value of this parameter is a dimensionless representation of the required flow rate or pressure. Value 32000 corresponds to 100 %.



To convert Measure and Setpoint to actual mass or volume flows (F_{measure} and F_{setpoint} respectively), use parameters Capacity and Capacity Unit (see [Fluid set](#))

Temperature

Type	Access	Range	FlowDDE	FLOW-BUS	Modbus
Float	R	-250...500	142	33/7	0xA138...0xA139/41273...41274

This parameter returns the internal temperature in the instrument housing in °C, which is an approximation of the actual media temperature.

Pressure

Type	Access	Range	FlowDDE	FLOW-BUS	Modbus
Float	RW	0...3.4E+38	143	33/8	0xA140...0xA141/41281...41282

In case an external pressure sensor is connected, this parameter returns the actual system pressure in bar(a). If there is no external pressure sensor, the default value of this parameter is equal to parameter *Inlet pressure*.

4.2.1 Advanced measurement and control

Fmeasure

Type	Access	Range	FlowDDE	FLOW-BUS	Modbus
Float	R	-3.4E+38... 3.4E+38	205	33/0	0xA100...0xA101/ 41217...41218

This parameter represents the value of parameter *Measure*, expressed in the selected *Capacity Unit*. Its value is calculated from the dimensionless value of *Measure*, using the fluid set parameters *Capacity 100%* and *Capacity Unit*.

Fsetpoint

Type	Access	Range	FlowDDE	FLOW-BUS	Modbus
Float	RW	0...3.4E+38	206	33/3	0xA118...0xA119/ 41241...41242

This parameter represents the value of parameter *Setpoint*, expressed in the selected *Capacity Unit*. Conversion between *Fsetpoint* and the dimensionless value of *Setpoint* uses fluid set parameters *Capacity 100%* and *Capacity Unit*.

Setpoint Slope

Type	Access	Range	FlowDDE	FLOW-BUS	Modbus
Unsigned int	RW	0...30000	10	1/2	0x0022/35

The value of this parameter represents the time it would take to adjust the setpoint if it were changed from 0 to 100 %. This feature can be used to smooth 'nervous' controller behavior, e.g. to reduce setpoint overshoot or undershoot. The supported range corresponds to 0...3000 seconds. Default value = 0.

Example:

If *Setpoint Slope* = 100 it will take 10 seconds to adjust the setpoint if it is changed from 0 to 100%. A setpoint change of 20% will take $(20\%/100\%)*10$ seconds = 2 seconds.

Analog Input

Type	Access	Range	FlowDDE	FLOW-BUS	Modbus
Unsigned int	R	0...65535	11	1/3	0x0023/36

This parameter contains a digital translation of the analog input signal (if applicable).

Valve Output

Type	Access	Range	FlowDDE	FLOW-BUS	Modbus
Unsigned long	RW	0... 16777215	55	114/1	0xF208...0xF209/61961...61962

This parameter represents the controller output signal for control valve operation.

4.3 Device identification

User Tag

Type	Access	Range	FlowDDE	FLOW-BUS	Modbus
Unsigned char[16]	RW	-	115	113/6	0xF130...0xF137/ 61745...61752

With this parameter, the instrument can be given a custom tag name, with a maximum of 16 characters.

Customer Model

Type	Access	Range	FlowDDE	FLOW-BUS	Modbus
Unsigned char[16]	RW 	-	93	113/4	0xF120...0xF127/ 61729...61736

This parameter is used to add extra information to the model number information, such as a customer-specific model number.

Serial Number

Type	Access	Range	FlowDDE	FLOW-BUS	Modbus
Unsigned char[20]	R	-	92	113/3	0xF118...0xF11F/ 61721...61728

Instrument serial number for identification.

BHT Model Number

Type	Access	Range	FlowDDE	FLOW-BUS	Modbus
Unsigned char[35]	RW 	-	91	113/2	0xF110...0xF117/ 61713...61720

This parameter shows the Bronkhorst® instrument model type information.

Firmware Version

Type	Access	Range	FlowDDE	FLOW-BUS	Modbus
Unsigned char[6]	R	-	105	113/5	0xF128...0xF12A/ 61737...61739

Revision number of the firmware

Identification Number

Type	Access	Range	FlowDDE	FLOW-BUS	Modbus
Unsigned char	RW 	0...255	175	113/12	0x0E2C/3629

Bronkhorst® (digital) device type identification number.

Device Type

Type	Access	Range	FlowDDE	FLOW-BUS	Modbus
Unsigned char[6]	R	-	90	113/1	0xF108...0xF10A/ 61705...61707

Device type information string; this parameter contains an abbreviation referring to the identification number.

4.4 Alarms

Alarm settings are most easily accessible using FlowSuite, FlowPlot or FlowView or a Bronkhorst® readout and control unit.

The built-in alarm functionality can be used to handle different alarm types:

- system errors and warnings
- min/max alarms
- response alarms
- batch alarms
- master/slave alarms

The alarm type can be set with parameter *Alarm Mode*. When an alarm is activated, the type can be read out using parameter *Alarm Info*. An automatic setpoint change can be set using the parameters *Alarm Setpoint Mode* and *Alarm New Setpoint*. It is also possible to set an alarm delay, to prevent overreaction to small disturbances, using parameter *Alarm Delay Time*. The methods by which an alarm can be reset are controlled by *Reset Alarm Enable*.

Alarm Mode

Type	Access	Range	FlowDDE	FLOW-BUS	Modbus
Unsigned char	RW	0...3	118	97/3	0x0C23/3108

Available modes:

Value	Description
0	Alarm off
1	Alarm on absolute limits
2	Alarm on limits related to setpoint (response alarm)
3	Alarm at power-up (e.g. after power-down)

(On DeviceNet™ instruments, only modes 0 and 1 are available)

Alarm Info

Type	Access	Range	FlowDDE	FLOW-BUS	Modbus
Unsigned char	R	0...255	28	1/20	0x0034/53

This parameter provides information about the event type(s) that triggered an alarm situation. The value is a bitwise summation of the issued alarm types; convert the value to binary to see which types are issued. The following alarm types can be issued:

Bit	Value	Type	Description
0	1	Error	Error flag raised
1	2	Warning	Warning flag raised
2	4	Minimum alarm	<i>Measure</i> < <i>Alarm minimum limit</i>
3	8	Maximum alarm	<i>Measure</i> > <i>Alarm maximum limit</i>
4	16	Batch counter alarm	Batch counter reached its limit
5	32	<ul style="list-style-type: none"> • This bit only: Power-up alarm • If combined with bit 2 or 3: Response alarm 	Alarm possibly caused by a power dip Difference between <i>Measure</i> and <i>Setpoint</i> too big
6	64	Master/slave alarm	Setpoint out of limits (caused by <i>Slave factor</i>)
7	128	Hardware alarm	Hardware error

Alarm Delay Time

Type	Access	Range	FlowDDE	FLOW-BUS	Modbus
Unsigned char	RW	0...255	182	97/7	0x0C27/3112

This value represents the time in seconds the alarm action will be delayed when an alarm limit has been exceeded. This value also delays the alarm off action if an alarm limit is no longer exceeded.
Default value = 0.

Alarm Maximum Limit

Type	Access	Range	FlowDDE	FLOW-BUS	Modbus
Unsigned int	RW	0...32000	116	97/1	0x0C21/3106

Maximum limit for *Measure* to activate the maximum alarm situation (after *Alarm Delay Time*). Range 0...32000 represents 0...100% signal. *Alarm Maximum Limit* must be greater than *Alarm Minimum Limit*.
Default value: 0.

Alarm Minimum Limit

Type	Access	Range	FlowDDE	FLOW-BUS	Modbus
Unsigned int	RW	0...32000	117	97/2	0x0C22/3107

Minimum limit for *Measure* to activate the minimum alarm situation (after *Alarm Delay Time*). Range 0...32000 represents 0...100% signal. *Alarm Minimum Limit* must be smaller than *Alarm Maximum Limit*.
Default value: 0.

Alarm Setpoint Mode

Type	Access	Range	FlowDDE	FLOW-BUS	Modbus
Unsigned char	RW	0...1	120	97/5	0x0C25/3110

Specifies whether or not to change the setpoint after an alarm situation is activated.

Value	Description
0	No setpoint change (default)
1	Change setpoint to <i>Alarm new setpoint</i>

Alarm New Setpoint

Type	Access	Range	FlowDDE	FLOW-BUS	Modbus
Unsigned int	RW	0...32000	121	97/6	0x0C26/3111

New (safe) setpoint during an alarm until reset. Range 0...32000 represents 0...100% setpoint.
Default value: 0

Reset Alarm Enable

Type	Access	Range	FlowDDE	FLOW-BUS	Modbus
Unsigned char	RW	0...15	156	97/9	0x0C29/3114

Available reset methods. The value is a bitwise summation of the enabled methods; convert the value to binary to see which methods are enabled.

Default value: 15 (all bits/methods enabled)

The following methods are supported:

Bit	Value	Description
0	1	By hardware switch (if present)
1	2	Externally (obsolete)
2	4	By parameter <i>Reset</i>
3	8	Automatically (when alarm conditions no longer apply)

4.5 Counter

- Counter settings are most easily accessible using FlowSuite, FlowPlot or FlowView or a Bronkhorst® readout and control unit.
- When the instrument is powered down, it remembers the state of the counter. If the counter is active when the instrument is powered down, it is activated when powered up and then continues to count from the value at the time of power down.

Counter Mode

Type	Access	Range	FlowDDE	FLOW-BUS	Modbus
Unsigned char	RW	0...2	130	104/8	0x0D08/3337

Available modes:

Value	Description
0	Counter off (default)
1	Counting up continuously
2	Counting up until limit reached (set by <i>Counter Limit</i>)

Counter Unit

Type	Access	Range	FlowDDE	FLOW-BUS	Modbus
Unsigned char[4]	RW	see table below	128	104/7	0xE838...0xE839/59449...59450

This parameter contains the name of the counter readout unit.

Counter Unit supports the following values:

Mass	Normal volume (1.01325 bar(a), 0 °C)	Standard volume (1.01325 bar(a), 20 °C)	Custom volume (Capacity Unit Pressure, Capacity Unit Type Temperature)
ug, mg, g, kg	uln, mln, ln, mm3n, cm3n, dm3n, m3n	uls, mls, ls, mm3s, cm3s, dm3s, m3s	ul, ml, l, mm3, cm3, dm3, m3

Counter Value

Type	Access	Range	FlowDDE	FLOW-BUS	Modbus
Float	RW	0... 10000000	122	104/1	0xE808...0xE809/59401...59402

Current counter value in units selected with parameter *Counter Unit*.

Counter Limit

Type	Access	Range	FlowDDE	FLOW-BUS	Modbus
Float	RW	0...9999999	124	104/3	0xE818...0xE819/59417...59418

Counter limit/batch size in units selected with parameter *Counter Unit*.
Default value: 0.

Counter Setpoint Mode

Type	Access	Range	FlowDDE	FLOW-BUS	Modbus
Unsigned char	RW	0...1	126	104/5	0x0D05/3334

Specifies whether or not to change the setpoint after reaching the counter limit.

Value	Description
0	No setpoint change (default)
1	Change setpoint to <i>Counter new setpoint</i>

Counter New Setpoint

Type	Access	Range	FlowDDE	FLOW-BUS	Modbus
Unsigned int	RW	0...32000	127	104/6	0x0D06/3335

New (safe) setpoint when a counter limit is reached until reset. Range 0...32000 represents 0...100% setpoint.
Default value: 0

Reset Counter Enable

Type	Access	Range	FlowDDE	FLOW-BUS	Modbus
Unsigned char	RW	0...15	157	104/9	0x0D09/3338

Available reset methods. The value is a bitwise summation of the enabled reset methods; convert the value to binary to see which methods are enabled.

Default value: 7 (bits/methods 0, 1 and 2 enabled)

The following methods are supported:

Bit	Value	Description
0	1	By hardware switch (if present)
1	2	Externally (obsolete)
2	4	By parameter <i>Reset</i>
3	8	Automatically (e.g. when counter value is reset)

4.6 Network configuration

Changes made to the network settings will **not** be restored by a factory reset.

Default settings

Network configuration is done ex factory as ordered. The table below shows the supported configurations for the available interface protocols (default settings are printed in bold):

Protocol	ProPar (RS-232)	FLOW-BUS (RS-485)	Modbus (RTU/ASCII)	PROFIBUS DP	CANopen	DeviceNet™
Address	3	3 ...125	1 ...247	0... 126	1... 127	0... 63
Baud Rate	9600 19200 38400 57600 115200 230400 460800	187500 400000	9600 19200 38400 56000 57600 115200 128000 256000	(autodetect) 9600 19200 45450 93750 187500 500000 1500000 3000000 6000000 12000000	10000 20000 50000 125000 250000 500000 800000 1000000	125000 250000 500000
Parity	0	0	0, 1, 2	2	0	0

Network configuration for Ethernet based fieldbus types is done automatically via the Ethernet protocol.

Communication via fieldbus connection (RS485)

Use the following parameters to configure the instrument for communication via the fieldbus connection:



Network parameter settings for fieldbus communication can be overruled by the [rotary switches](#) (if present).

Fieldbus1 Address

Type	Access	Range	FlowDDE	FLOW-BUS	Modbus
Unsigned char	RW	0...255	199	125/10	0x0FAA/4011

Fieldbus1 Baud Rate

Type	Access	Range	FlowDDE	FLOW-BUS	Modbus
Unsigned long	RW	0...1.0E10	201	125/9	0xFD48...0xFD49/64841...64842

Fieldbus1 Parity

Type	Access	Range	FlowDDE	FLOW-BUS	Modbus
Unsigned char	RW	0...2	335	125/12	0x0FAC/4013

The following values are supported:

Value	Description
0	No parity
1	Odd parity
2	Even parity

Communication via the power supply connection (RS232/RS485)

Use the following parameters to configure the instrument for communication via the 9-pin D-sub (power) connection:



- If the 9-pin D-sub connector is set for RS-485 communication, the instrument will not respond to an RS-232 master. In that case, use the [multifunctional switch](#) to enter configuration mode and enable RS-232 communication.
- After configuring the required parameters, follow the same procedure to leave configuration mode and restore the original communication settings (otherwise, configuration mode will remain enabled after the next power-up).

Fieldbus2 Address

Type	Access	Range	FlowDDE	FLOW-BUS	Modbus
Unsigned char	RW	0...255	309	124/10	0x0F8A/3979

Fieldbus2 Baud Rate

Type	Access	Range	FlowDDE	FLOW-BUS	Modbus
Unsigned long	RW	0...1.0E10	310	124/9	0xFC48...0xFC49/64585...64586

Fieldbus2 Parity

Type	Access	Range	FlowDDE	FLOW-BUS	Modbus
Unsigned char	RW	0...2	336	124/12	0x0F8C/3981

The following values are supported:

Value	Description
0	No parity
1	Odd parity
2	Even parity

4.7 Fluid set



For changing fluid, flow range or operating conditions, using the FlowTune software is advised. FlowTune checks any changes for compatibility of the process conditions with the instrument. When the parameters described in this section are changed manually, no such checks are performed, and the instrument output may become disordered or the instrument may even get damaged if used in conditions the instrument is not suited for. When in doubt, consult your Bronkhorst representative.

Fluid Set Index

Type	Access	Range	FlowDDE	FLOW-BUS	Modbus
Unsigned char	RW	0...7	24	1/16	0x0030/49

With this parameter, any of the pre-configured fluids (up to 8) can be selected. Each fluid has its specific (configurable) properties, such as *Fluid Name*, *Capacity*, etc.
Default value: 0 (fluid 1).

Note that the selected value is equal to the fluid number minus 1 (value 0 corresponds to fluid 1, value 1 to fluid 2, etc.)

Fluid Name

Type	Access	Range	FlowDDE	FLOW-BUS	Modbus
Unsigned char[10]	RW	-	25	1/17	0x8188...0x818C/33161...33165

This parameter contains the name of the selected fluid.

Capacity 100%

Type	Access	Range	FlowDDE	FLOW-BUS	Modbus
Float	RW 	1E-10... 1E+10	21	1/13	0x8168...0x8169/33129...33130

- This parameter represents the 100 % readout/control value (span) for the selected fluid, expressed in the selected *Capacity Unit*.
- *Capacity 100%* is scaled when *Inlet Pressure*, *Fluid Temperature* or *Fluid Name* is changed for the selected fluid.

Capacity Unit

Type	Access	Range	FlowDDE	FLOW-BUS	Modbus
Unsigned char[7]	RW 	see below	129	1/31	0x81F8...0x81FB/33273...33276

This parameter represents the unit in which *Capacity 100%* is expressed.

Available units:

Mass flow	Normal volume flow (1.01325 bar(a), 0 °C)	Standard volume flow (1.01325 bar(a), 20 °C)	Custom volume flow (<i>Capacity Unit Type Pressure</i> , <i>Capacity Unit Type Temperature</i>)
ug/h, ug/min, ug/s, mg/h, mg/min, mg/s, g/h, g/min, g/s, kg/h, kg/min, kg/s	uln/h, uln/min, uln/s, mln/h, mln/min, mln/s, ln/h, ln/min, ln/s, ccn/h, ccn/min, ccn/s, mm3n/h, mm3n/m, mm3n/s, cm3n/h, cm3n/m, cm3n/s, m3n/h, m3n/min, m3n/s, scfh, scfm, scfs, sccm, slm	uls/h, uls/min, uls/s, mls/h, mls/min, mls/s, ls/h, ls/min, ls/s, ccs/h, ccs/min, ccs/s, mm3s/h, mm3s/m, mm3s/s, cm3s/h, cm3s/m, cm3s/s, m3s/h, m3s/min, m3s/s	ul/h, ul/min, ul/s, ml/h, ml/min, ml/s, l/h, l/min, l/s, cc/h, cc/min, cc/s, mm3/h, mm3/m, mm3/s, cm3/h, cm3/m, cm3/s, m3/h, m3/min, m3/s, cfh, cfm, cfs



Because of the maximum string length (7 characters), some unit names are abbreviated. For instance mm3n/m means mm³n/min.

Capacity Unit Type Temperature

Type	Access	Range	FlowDDE	FLOW-BUS	Modbus
Float	RW 	-273.15... 3.4E+38	245	33/10	0xA150...0xA151/41297...41298

This parameter defines a reference temperature for conversion of the measured mass flow to a volume flow. See also parameters *Capacity Unit* and *Counter Unit*.

Capacity Unit Type Pressure

Type	Access	Range	FlowDDE	FLOW-BUS	Modbus
Float	RW 	0...3.4E+38	246	33/11	0xA158...0xA159/41305...41306

This parameter defines a reference pressure for conversion of the measured mass flow to a volume flow. See also parameters *Capacity Unit* and *Counter Unit*.

4.7.1 Advanced fluid set parameters

Note that the parameters described in this section do not contain any actual measurement values, but only fixed reference values, which can be used for capacity calculations, etc.

Inlet Pressure

Type	Access	Range	FlowDDE	FLOW-BUS	Modbus
Float	RW 	0...3.4E+38	178	113/13	0xF168...0xF169/61801...61802

Upstream pressure of the selected fluid in bar(a)

Outlet Pressure

Type	Access	Range	FlowDDE	FLOW-BUS	Modbus
Float	RW 	0...3.4E+38	179	113/14	0xF170...0xF171/61809...61810

Downstream pressure of the selected fluid in bar(a).

Fluid Temperature

Type	Access	Range	FlowDDE	FLOW-BUS	Modbus
Float	RW 	-250...500	181	113/16	0xF180...0xF181/61825...61826

Temperature of the selected fluid in °C.

Density

Type	Access	Range	FlowDDE	FLOW-BUS	Modbus
Float	RW 	0...3.4E+38	170	33/21	0xA1A8...0xA1A9/41385...41386

Density of the selected fluid in kg/m³

Heat Capacity

Type	Access	Range	FlowDDE	FLOW-BUS	Modbus
Float	RW 	0...3.4E+38	250	113/18	0xF190...0xF191/61841...61842

Heat capacity of the selected fluid in J/kg·K

Thermal Conductivity

Type	Access	Range	FlowDDE	FLOW-BUS	Modbus
Float	RW 	0...3.4E+38	251	113/20	0xF1A0...0xF1A1/61857...61858

Thermal conductivity of the selected fluid in W/m·K

Viscosity

Type	Access	Range	FlowDDE	FLOW-BUS	Modbus
Float	RW 	0...3.4E+38	252	113/21	0xF1A8...0xF1A9/61865...61866

Dynamic viscosity of the selected fluid in Pa·s

4.8 Master/slave configuration (FLOW-BUS)

Normally, there is no communication between the instruments in a fieldbus system. The FLOW-BUS protocol, however, provides a feature to set up a master/slave relationship between two instruments. The typical behavior of a slave instrument is to automatically set its own setpoint relative to the output (measurement value) of its master.

The output value of any instrument in a FLOW-BUS network is automatically available to all other instruments without extra wiring. A slave instrument can also be a master to other instruments.

To set up a master/slave relationship between instruments, set parameter *Control Mode* of the slave instrument to 'FLOW-BUS slave' (value 2) or 'FLOW-BUS analog slave' (value 13), depending on how the setpoint should be calculated.

The slave instrument polls the output value of its master periodically and uses the slave factor to set its own setpoint

relative to the master's.



To prevent damage to the instruments an/or the system(s) they are connected to, be sure to avoid circular references between devices on the same fieldbus. The FLOW-BUS system does not have a protection mechanism.

Master Node

Type	Access	Range	FlowDDE	FLOW-BUS	Modbus
Unsigned char	RW	1...128	158	33/14	n/a

Sets the master node for the instrument.

Note that this parameter is only effective in a FLOW-BUS network (RS-485).

Slave Factor

Type	Access	Range	FlowDDE	FLOW-BUS	Modbus
Float	RW	0...500	139	33/1	0xA108...0xA109/41225...41226

The controller output from the master instrument is multiplied by *Slave Factor*/100 % to get the slave instrument setpoint. In systems other than FLOW-BUS, *Slave Factor* is effective only if *Control Mode* is set to 'Analog slave', and the analog output signal of the master instrument is redirected to the input of the slave instrument.

Example:

- master output = 80 %
 - *Slave Factor* = 50
- ⇒ slave instrument setpoint = 80 % x 50 %/100 % = 40 %

5 Troubleshooting and service



- Electronic problems can be traced by restarting the equipment.
- If the equipment starts up normally, the measurement and control behavior can be checked by applying fluid pressure.
- To track down problems in the fluid system, depressurize the fluid system and disconnect the suspected unit from the process line. Dirt or clogging might be quickly detected by visual inspection of disassembled fluid connections.



If you suspect leakage, do not disassemble the device for inspection, but contact your Bronkhorst representative for service or repairs.

5.1 Errors and warnings



- During operation, the LEDs can indicate errors and/or warnings. See [LED indications](#) for an explanation of the LED indications the instrument can give.
- Error and warning information can also be found by connecting the instrument to FlowDDE and FlowPlot. FlowDDE puts all errors and warnings on the console screen; FlowPlot provides several specific alarm and counter indicators. See also section [Digital operation \(RS232\)](#).

5.2 Restoring factory settings

In case changes to the instrument configuration leads to non-recoverable erroneous behavior, the instrument can be reset to the pre-configured factory settings. The easiest way to do this is with the multifunctional switch on top of the instrument.

To restore the factory settings using the multifunctional switch, follow these instructions:

1. Make sure electrical power to the instrument is switched off.
2. Press and hold the multifunctional switch, while powering up the instrument. After 4 seconds, the red LED ● starts flashing (0.2 seconds on, 0.2 seconds off).
3. At that moment (which is after 4 to 8 seconds), release the switch.



Changes made to the network settings (bus address, baud rate, parity) will **not** be restored by a factory reset.



Alternatively, factory settings can be restored in FlowPlot (via RS232 communication), or with a Bronkhorst® readout and control unit (BRIGHT, E-8000).
If RS232 communication with the instrument can not be established, use the power-up functionality of the [multifunctional switch](#) to switch to configuration mode and enable RS232 communication.
After restoring the factory settings, remember to leave configuration mode and restore the original communication settings (otherwise, configuration mode remains enabled after power down).

5.3 Common issues

Symptom	Possible cause	Action
No (fieldbus) communication	No power supply	<ul style="list-style-type: none"> • Check power supply • Check cable connection • Check cable hook-up
	Invalid node address	Change node address (see Network configuration)
	Other	Reset instrument and/or restart master. If problem persists, contact Bronkhorst.
No output signal	No power supply	<ul style="list-style-type: none"> • Check power supply • Check cable connection • Check cable hook-up
	Invalid control mode (instrument accepts no setpoint)	Check control mode (see Special parameters)
	No setpoint given or setpoint too low	Give setpoint $\geq 2\%$
	Control valve in Safe State (normally closed)	Check if control valve is in safe state; solve cause if necessary (see Valve Safe State)
	Inlet pressure or differential pressure too low	Increase inlet pressure
	Piping, filters and/or control valve clogged or blocked	<ul style="list-style-type: none"> • Flush fluid system with clean, dry air. If problem persists, contact Bronkhorst. • For external proportional control valves: supply 0...15 Vdc and operational inlet pressure to valve and slowly increase voltage. If valve does not open, clean parts and re-adjust valve
	Laminar flow element clogged or blocked	Return equipment to factory
	Sensor failure	Return equipment to factory
Control behavior unstable	Measurement disturbed by vibrations	If possible, avoid installation in close proximity of mechanical vibration
	Inlet pressure unstable	Install pressure regulator or increase buffer volume between controlling instruments (see section Piping requirements)
	Inlet and/or outlet pressure too high or too low	Adjust pressure and/or set instrument pressure in accordance with actual process pressure (e.g. with FlowTune™)
	Wrong process gas selected	Select correct process gas (e.g. with FlowTune™)
	Wrong controller settings	Adjust settings (e.g. with FlowPlot)
	Control valve damaged	Return equipment to factory
No flow (sending a setpoint has no effect)	No fluid supply	Check upstream components for obstruction, e.g.: <ul style="list-style-type: none"> • fluid lines • valves • filters
	Setpoint too low	Give setpoint $\geq 2\%$
	Inlet pressure or differential pressure out of bounds	Set inlet pressure to a value within specifications

Symptom	Possible cause	Action
Measured value rises, but never reaches setpoint	Piping, filters and/or control valve clogged or blocked	<ul style="list-style-type: none"> Flush fluid system with clean, dry air. If problem persists, contact Bronkhorst. For external proportional control valves: supply 0...15 Vdc and operational inlet pressure to valve and slowly increase voltage. If valve does not open, clean parts and re-adjust valve
	Inlet pressure too low	Increase inlet pressure
	Outlet pressure too high	Check/decrease outlet pressure
	Process outlet blocked	Check process outlet and downstream piping
Measured value or output signal (much) lower than setpoint	Inlet pressure or differential pressure too low	<ul style="list-style-type: none"> Increase inlet pressure Use instrument in conditions it was designed for
	Process gas condensation	Decrease inlet pressure or increase gas temperature
	<ul style="list-style-type: none"> Piping, filters and/or control valve clogged or blocked Sensor blocked or contaminated 	Flush fluid system with clean, dry air. If problem persists, contact Bronkhorst.
	Supplied fluid type does not match configured fluid type	Supply equipment with other fluid or change fluid type in instrument configuration
Measured value or output signal indicates a flow, while there is none	Mounting orientation and/or ambient conditions changed significantly	<ul style="list-style-type: none"> Use instrument in conditions it was designed for Adjust zero point (see Adjusting zero point)
	System leakage	Check the system for leakage. Follow vendor instructions when installing third party components (e.g. adapters, tubing, valves)
Continuous maximum measured value or output signal	Inlet pressure too high	Check inlet pressure
	Valve fully open	<ul style="list-style-type: none"> Close valve Check if control valve is in Safe State (normally open valves); remove cause if necessary (see Valve Safe State)
	Sensor failure	Return equipment to factory

5.4 Service

For current information about Bronkhorst® and worldwide service addresses, please visit our website:



www.bronkhorst.com

Do you have any questions about our products? Our Sales department will gladly assist you selecting the right product for your application. Contact sales by e-mail:



sales@bronkhorst.com

For after-sales questions, help and guidance, our Customer Care department is available by e-mail:



aftersales@bronkhorst.com

No matter the time zone, our experts within the Customer Care department are available to answer your request immediately or take appropriate further action. Our experts can be reached at:



+31 859 02 18 66

Bronkhorst High-Tech B.V.
Nijverheidsstraat 1A
NL-7261 AK Ruurlo
The Netherlands

6 Returns

6.1 Removal and return instructions

When returning materials, always clearly describe the problem, and, if possible, the work to be done, in a covering letter.

Instrument handling:

1. Purge all fluid lines (if applicable)
2. If the instrument has been used with toxic or otherwise hazardous fluids, it must be cleaned before shipping
3. Disconnect all external cabling and tubing and remove the instrument from the process line
4. If applicable, secure movable parts with appropriate transport safety materials, to prevent damage during transportation
5. The instrument must be at ambient temperature before packaging
6. Insert the instrument into a plastic bag and seal the bag
7. Place the bag in an appropriate shipping container; if possible, use the original packaging box

Add documentation:

- Reason of return
- Failure symptoms
- Contaminated condition
- Declaration on decontamination



It is absolutely required to notify the factory if toxic or dangerous fluids have been in contact with the device!
This is to enable the factory to take sufficient precautionary measures to safeguard the staff in their repair department.

All instruments must be dispatched with a completely filled in 'Declaration on decontamination'. Instruments without this declaration will not be accepted.



*A safety information document containing a 'Declaration on decontamination' form (document no 9.17.032) can be downloaded from the **Service & Support** section of the Bronkhorst website (www.bronkhorst.com).*

Important:

Clearly note, on top of the package, the customs clearance number of Bronkhorst High-Tech B.V.:

NL801989978B01

(only if applicable, otherwise contact your Bronkhorst representative for local arrangements.)

6.2 Disposal (end of lifetime)

If you are a customer within the European Union and wish to dispose of Bronkhorst® equipment bearing the symbol of a crossed out waste disposal bin, you can return it in accordance with the [removal and return instructions](#). Bronkhorst will then take care of proper dismantling, recycling and/or reuse (wherever possible). In the covering letter, mention that you are returning the product for disposal.

In countries outside the EU, disposal of electrical and electronic equipment (EEE) may be subject to local or national directives and/or legislation. If applicable, consult local or national authorities to learn how to handle EEE properly in your area.



Parameter index

Parameters

Parameters - Alarms

Alarm Delay Time	41
Alarm Info	41
Alarm Maximum Limit	41
Alarm Minimum Limit	41
Alarm Mode	40
Alarm New Setpoint	42
Alarm Setpoint Mode	41
Reset Alarm Enable	42

Parameters - Counter

Counter Limit	43
Counter Mode	42
Counter New Setpoint	43
Counter Setpoint Mode	43
Counter Unit	42
Counter Value	43
Reset Counter Enable	43

Parameters - Device identification

BHT Model Number	39
Customer Model	39
Device type	40
Firmware version	40
Identification number	40
Serial Number	39
User Tag	39

Parameters - Fluid set

Capacity 100%	46
Capacity Unit	46
Capacity Unit Type Pressure	46
Capacity Unit Type Temperature	46
Fluid Name	45
Fluid Set Index	45

Parameters - Fluid set (advanced)

Density	47
Fluid Temperature	47
Heat Capacity	47
Inlet Pressure	47
Outlet Pressure	47
Thermal Conductivity	47
Viscosity	47

Parameters - Master/Slave

Master Node	48
Slave Factor	48

Parameters - Measurement and control

Analog Input	39
--------------	----

Fmeasure	38
Fsetpoint	38
Measure	38
Pressure	38
Setpoint	38
Setpoint Slope	39
Temperature	38
Valve Output	39

Parameters - Network configuration

Fieldbus1 Address	44
Fieldbus1 Baud Rate	44
Fieldbus1 Parity	44
Fieldbus2 Address	45
Fieldbus2 Baud Rate	45
Fieldbus2 Parity	45

Parameters - Special

Control Mode	36
Init Reset	36
IO Status	37
Reset	36
Wink	36