

Pressure Handbook

A Basic Guide to Understanding Pressure

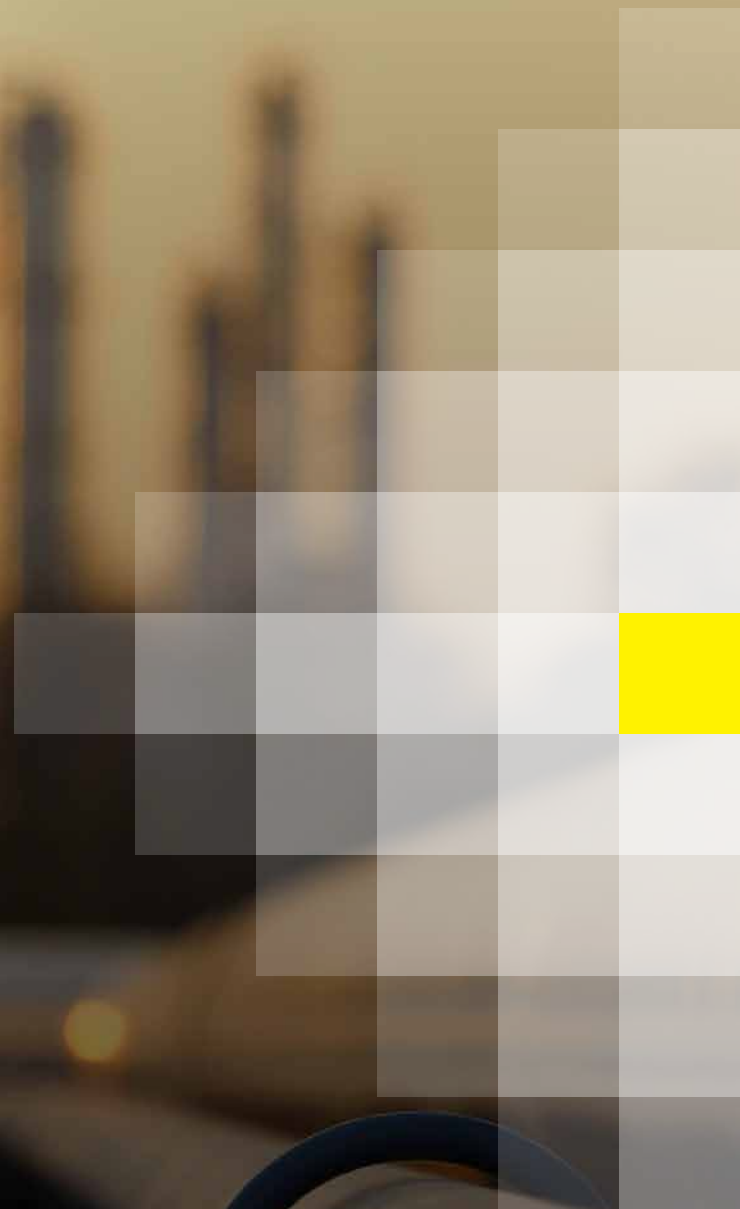

What to Expect

Foreword.....	03
What is Pressure?	04
Basic Physics of Pressure.....	06
Pressure Sensors	11
Transmitters	16
Communication Standards.....	19
Key Characteristics	22
Diaphragm Seals.....	24



Foreword

As industries strive to improve control of processes, the quality of the measurement of that process is often overlooked. Good quality measurement is the first requirement of any control scheme, new or old. No matter how good your DCS, PLC, SCADA, or cloud-based data collection is, if you do not have accurate reliable process data, it does not matter.

The flip side of the same coin is having a good DCS, PLC, SCADA, or cloud-based data collection. No matter how good your process measurement is, if you do not have any means to collect it and use it, the data is useless.

Process instruments and data collection and control platforms must work together to give users the best performance for the price, ultimately increasing our partner's profits. In the end, that is what we are all here for- to make a profit.

Accurately measuring pressure is a powerful piece of process data. Ultimately, the drive of any good pressure transmitter is to get an accurate, reliable pressure measurement to the data user quickly, which is what this eBook will discuss.



Kenneth Lee Hamlett
Product Manager Pressure Products
Yokogawa Corporation of America, Field Instruments

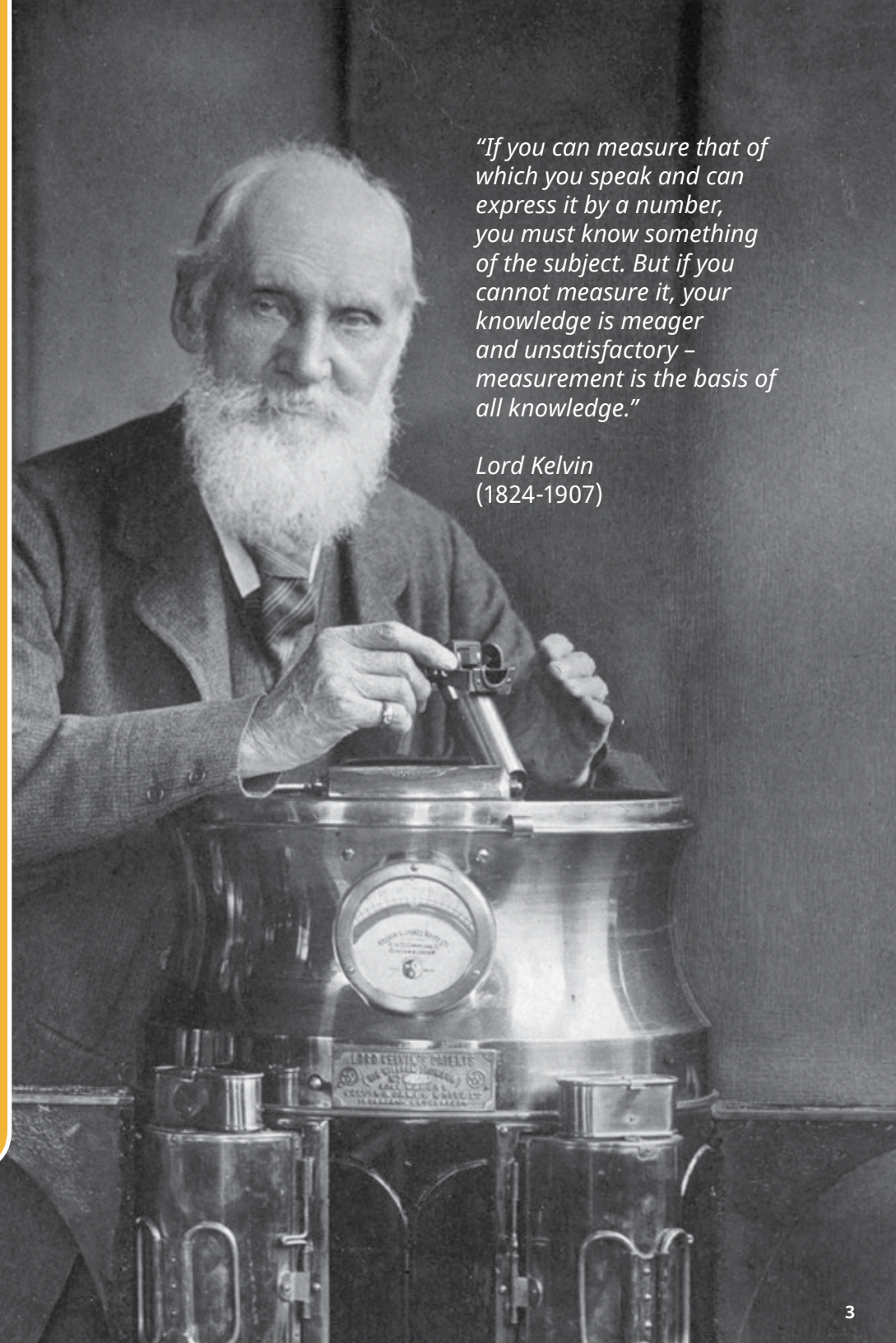

"If you can measure that of which you speak and can express it by a number, you must know something of the subject. But if you cannot measure it, your knowledge is meager and unsatisfactory – measurement is the basis of all knowledge."

Lord Kelvin
(1824-1907)

1

What is Pressure?



What is Pressure?

Pressure, temperature, level and flow are the four common plant measurements. Of the four, pressure is the most **fundamental** and **common**. The three remaining measurements can be inferred from pressure-flow (orifice plates, pitot tube, venturi), level (hydrostatic 'Head' pressure), and temperature (pressure thermometer). It can even be used to infer density (pressure for a given volume) and weight (load cells). **If you cannot measure it, you cannot control it.**

The ability to **quickly, accurately, and reliably** measure pressure is invaluable when trying to control a process.



Liquid Level Transmitter



Pressure Transmitter



Flow Transmitter



Pressure Thermometer

Each of these types of transmitters measures pressure. The flow transmitter, liquid level transmitter, and pressure thermometer use the measured pressure to infer another process parameter.

2 Basic Physics of Pressure

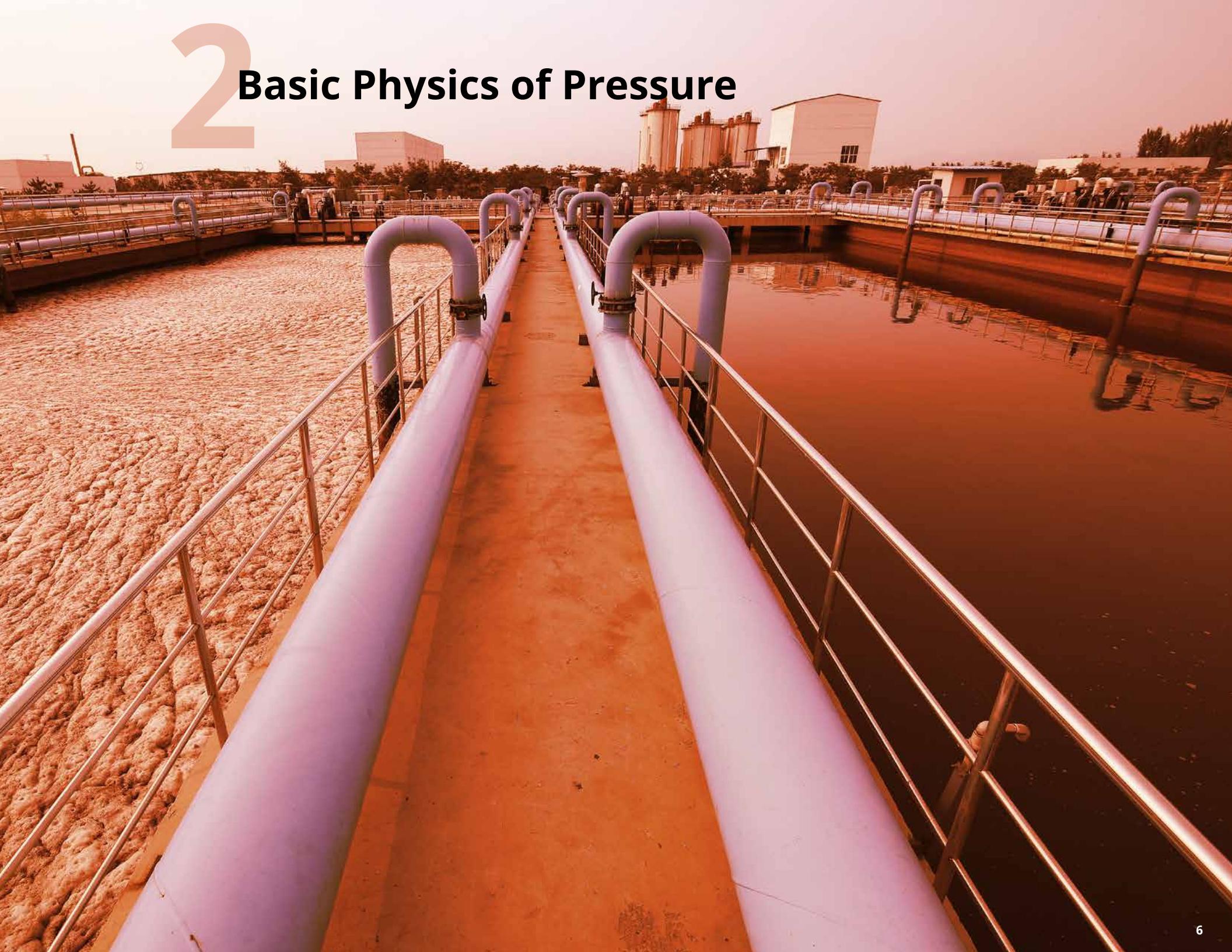

When a gas or a liquid is contained within a closed container, their molecules are in a constant, but random motion, constantly colliding with each other as well as with the container walls. All of these collisions occur over a given area combined to result in a force. This force over a defined area is referred to as **pressure**.

Basically...

$$P = \frac{F}{A}$$

P = Pressure

F = Force

A = Area

Pascal's Law (Gas and Liquids)

In the 1600s, Blaise Pascal developed his principle of transmission of fluid-pressure or more commonly known as Pascal's Law. This law states that a change in the pressure within the closed container will be conveyed equally in every direction within the container. Therefore, the pressure within the container can be measured from any point within the container.

Molecules in a constant random motion within a closed container



Blaise Pascal
1623-1662

REMEMBER! Pressure acts equally in all directions

Robert Boyle
1627-1691

Boyle's Law (Gas)

Also in the 1600s, Robert Boyle discovered a new law through experimentation. Boyle's Law states that as the volume of the container increases, the pressure decreases. Basically, gas expands to fill the volume available.

↕ ↕ Volume Increases - Pressure Decreases

Charles' Law (Gas)

Jacques Charles first described Charles' Law in an unpublished work in the 1780s. If the container sizes remain the same, Charles' Law states that a change in temperature of the contents of the container will directly affect the pressure in the container. As temperature increases in the container, the pressure of the container increases.

Temperature Increases - Pressure Increases ↕ ↕

Jacques Charles
1746-1823

Units of Measure

All pressure units of measure have two requirements:

- 1) Unit of force
- 2) Unit of area

One can write pages on the different units of measure that are in use. Every trade, occupation, and/or company has a favorite unit and is often reluctant to change for the sake of global standardization. Because of this, users need to be comfortable working with multiple units and converting between them – either by a conversion chart or the Internet.

The standard unit of measure in the English system is pounds per square inch (psi). In the MKS system, the standard unit is kilograms per square meter (kg/m^2). In the SI system, the standard unit is Newton per square meter (N/m^2) or Pascal (Pa).

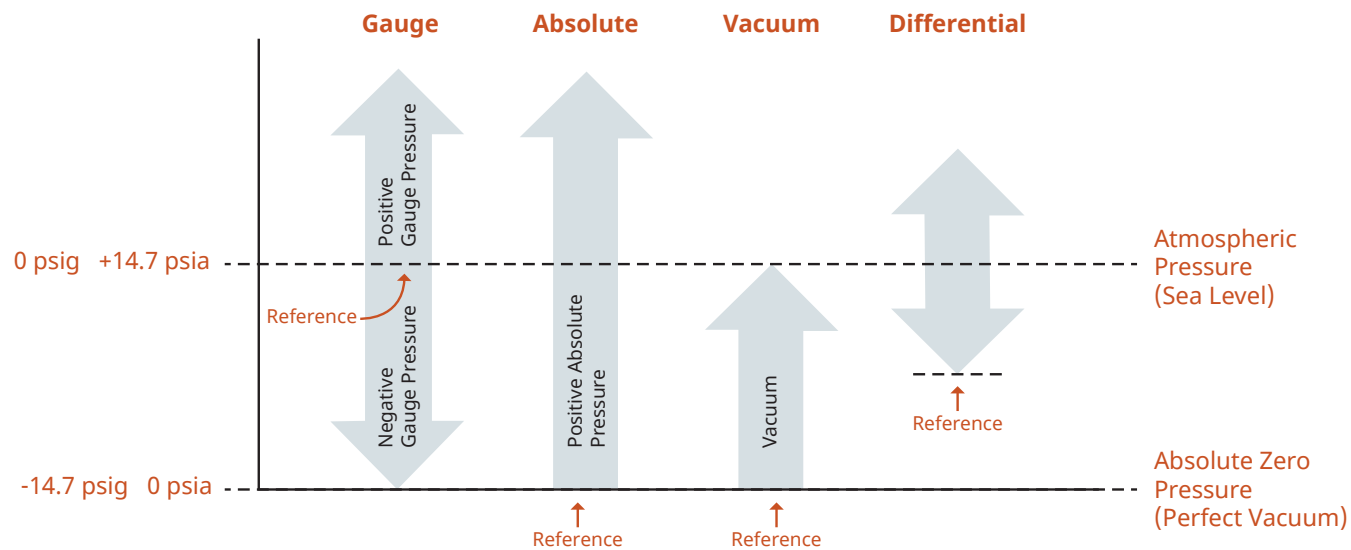

Pressure Reference

In industrial pressure measurement, there are four commonly used references: Gauge Pressure, Absolute Pressure, Differential Pressure, and Vacuum Pressure. These references supply a pressure point in which to compare a pressure.

Gauge Pressure

Use ambient atmospheric pressure as the reference. Gauge pressure transmitters have a small reference port to sample the ambient atmospheric pressure. With the real time sampling of this reference, today's highly accurate pressure transmitters can be affected by changes in local atmospheric pressure (i.e. a passing storm). The gauge pressure reading can be either positive or negative depending on it being greater than or less than the ambient atmospheric reference. Gauge pressure is indicated by the letter 'g' in the unit of measure (i.e. in H₂O (g) or psig). A common gauge pressure measurement that everyone comes in contact with is tire pressure. Tire pressure is a gauge pressure measurement that compares the pressure in the tire to the atmospheric pressure. **Example of industrial applications: open tank level, line pressure, blanket pressure in a tank**

Absolute Pressure

Use perfect vacuum pressure (absolute zero) as the reference. All absolute pressure measurements are positive. Although absolute pressure transmitters are not affected by changes in the local atmospheric pressure, they are typically more expensive than gauge pressure transmitters. Absolute pressure is indicated by the letter 'a' or the abbreviation 'abs' in the unit of measure (i.e. in H₂O (abs) or psia). **Example of industrial applications: open tank level, line pressure, blanket pressure in a wet/dry tank, plant atmospheric reference.**

Differential Pressure (DP)

The difference between two pressures. Differential pressure transmitters use a reference point called the low-side pressure and compare it to the high-side pressure. Ports in the instrument are marked high-side and low-side. The DP reading can be either negative or positive depending on whether the low-side or high-side is the larger value. A DP transmitter can be used as a gauge pressure transmitter if the low-side is left open to the atmosphere. **Example of industrial applications: closed tank level, density, filter health, flow**

Vacuum Pressure

The pressure between atmospheric pressure and absolute zero pressure. The standard defined reference is absolute zero pressure, but different companies, industries, and engineers define the reference point differently. If you have an instrument data sheet that uses the word vacuum, have the issuing company define their use of the word vacuum.

Pressure Sensors

3



Although there are many types of mechanical and electrical sensors on the market, all pressure sensors infer pressure by measuring a physical change within the sensor when exposed to changes in pressure. This physical change can be capacitance, resistance, or frequency. This section will review the types of sensors used with industrial pressure transmitters and include a description of the sensor's operation, advantages and disadvantages. This is not a complete list, but does cover 90% of the pressure transmitters currently on the market.

General

Common to all the technologies covered, each pressure sensor receives input from two sources. The sensor then compares the two inputs to generate the output signal. With differential pressure transmitters, the sensor compares two different process inputs (high pressure and low pressure).

A gauge pressure transmitter compares a measured pressure input to an atmospheric pressure input. An absolute pressure transmitter compares a measured pressure input to a vacuum.

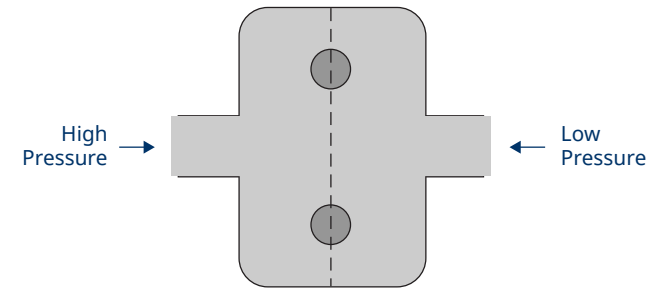

Differential Pressure Sensor

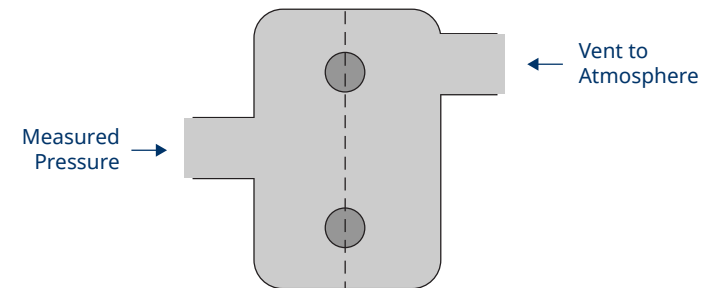

Gauge Pressure Sensor

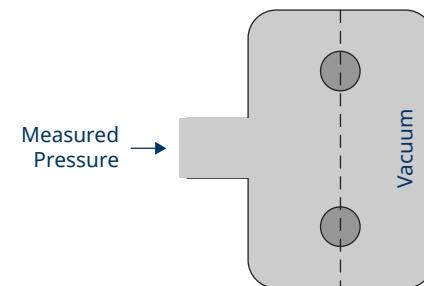

Absolute Pressure Sensor

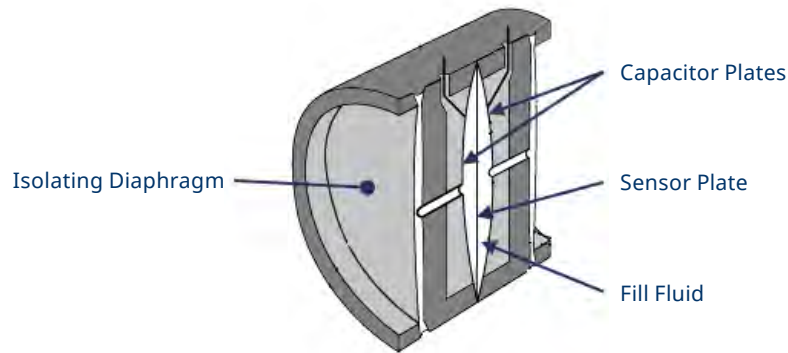

Typical Capacitance Pressure Sensor

Capacitance Pressure Sensor

A capacitance pressure sensor is basically a large capacitor formed by one fixed plate and one movable plate linked to the mechanical output of a diaphragm (via fill fluid). Between the plates is a dielectric material. The sensor also has an oscillator circuit to energize the capacitor and a capacitance detector circuit.

When the capacitor is energized, changes in pressure at the process diaphragm are hydraulically transferred to the moveable plate causing the distance between the plates to change. This change in distance changes the capacitance between the plates. The capacitance detector circuit senses the change in capacitance. The circuitry in the sensor is characterized to know that a Y change in capacitance equals an X change in pressure.

The output signal from this type of sensor is small and analog. The capacitance detector circuits must be carefully designed to weed out the effects of stray capacitance. Being an analog signal, an A/D convertor must be used to convert the signal to digital to be used by the transmitters' process circuitry.

Advantages

- Good low pressure performance
- Good vacuum range performance
- Mature design (used for 50+ years)

Disadvantages

- Electronically complex
- Measures only one process variable
- Produces an analog output signal (requires A/D converter)
- Low signal-to-noise ratio
- Does not handle overpressure events well
- Does not have a temperature sensor for temperature compensation (RTD must be located outside the sensor)
- It is a passive sensor



Piezoresistive Pressure Sensor

This sensor type uses Piezoresistive Effect to measure pressure. First discovered by Lord Kelvin in 1856, Piezoresistive Effect states that the resistance of a semiconductor changes as mechanical stress changes. This mechanical stress is caused by process pressure changes. During operation, changes in pressure at the process diaphragm are hydraulically transferred via fill fluid to the sensor diaphragm. The circuitry in the sensor is characterized to know that a Y change in resistance equals an X change in pressure.

Although there are different types of semiconductors that can be used, a single crystal silicon is the most widely used due to its excellent performance.

These sensors use four piezoresistors that are connected to form a Wheatstone Bridge circuit to maximize the output of the sensor and to reduce sensitivity errors. The output signal from this type of sensor is analog, so an A/D convertor must be used to convert the signal to digital format to be used by the transmitters' process circuitry.

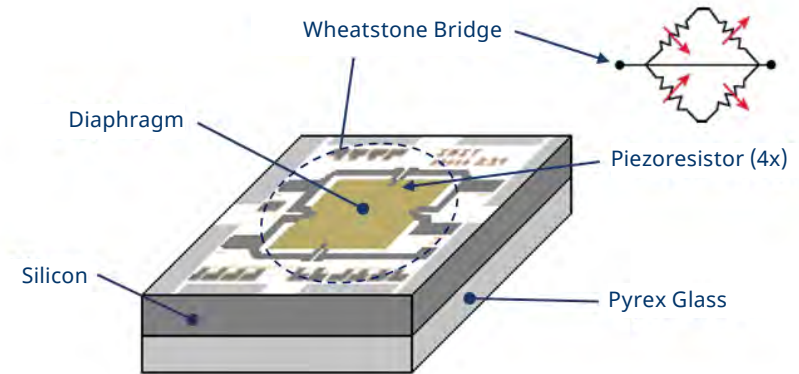

Advantages

- Good response time
- Easy to manufacture

Disadvantages

- Negatively affected by high temperature
- Negatively affected by high static pressures
- Measures only one process variable
- Produces an analog output signal (requires A/D converter)
- Does not handle overpressure events well
- Low signal-to-noise ratio
- Does not have a temperature sensor for temperature compensation (RTD must be located outside the sensor)
- It is a passive sensor

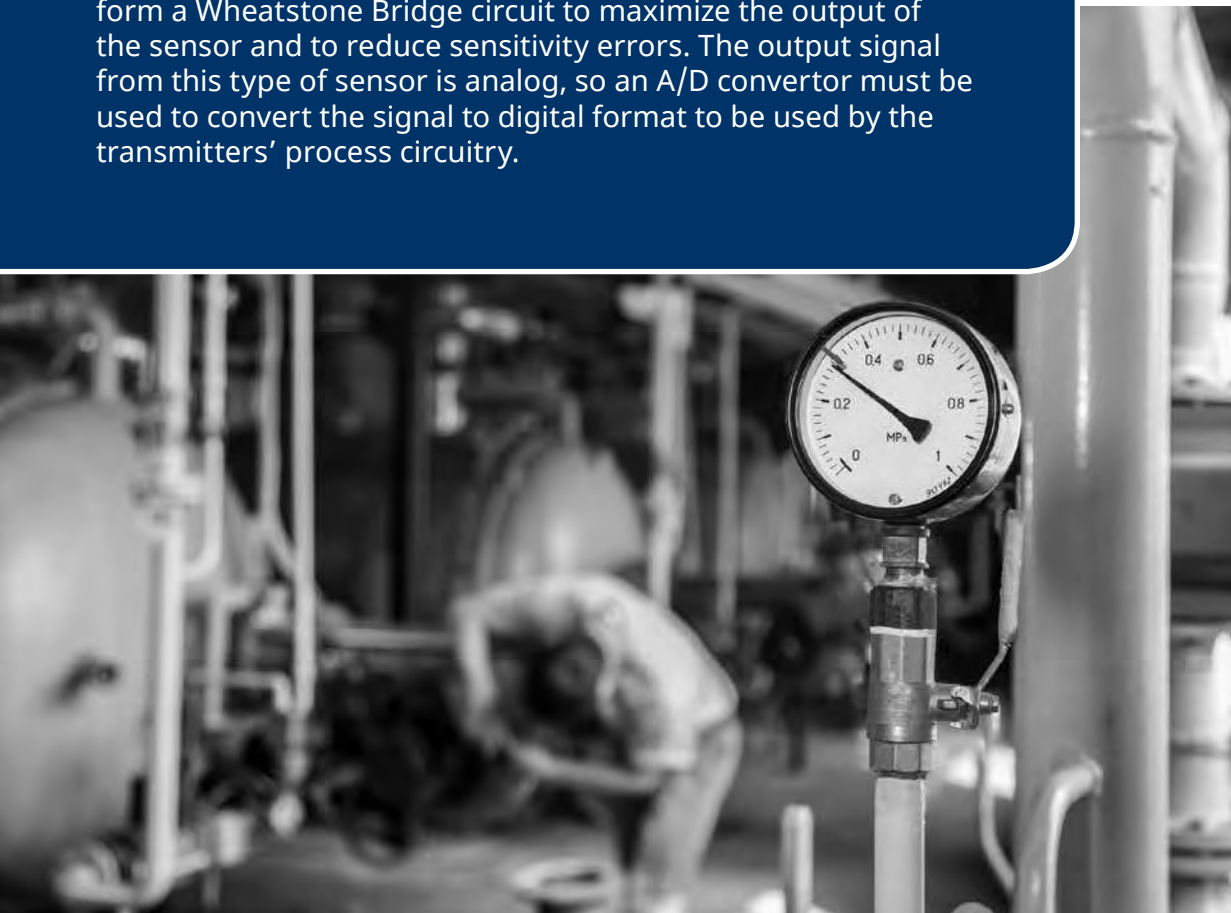

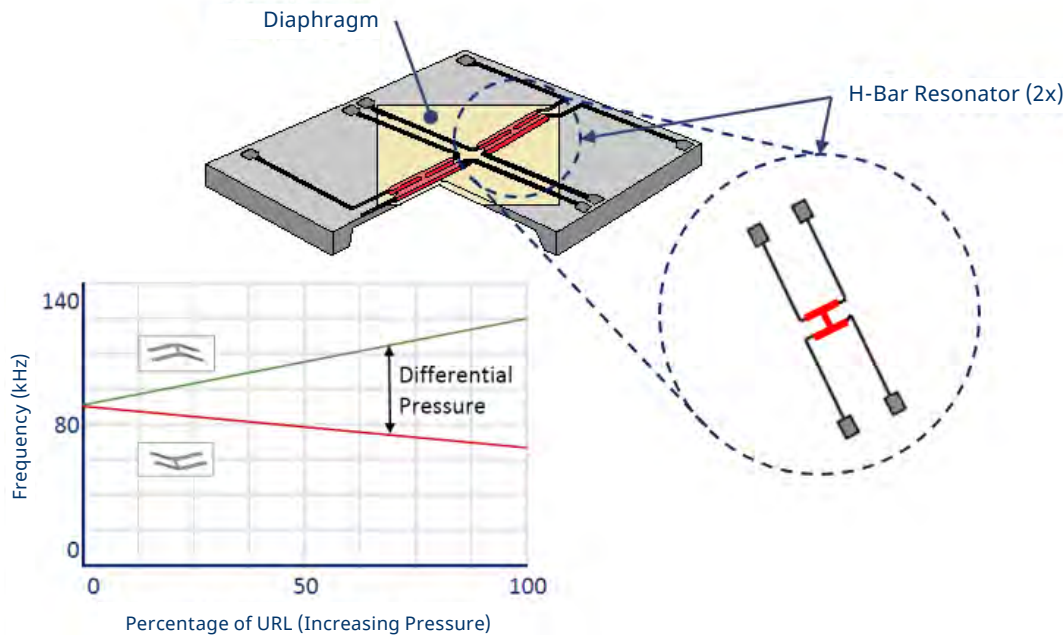

Advantages

- Very stable repeatable output (eliminating hysteresis)
- Highly accurate output
- Total digital signal
- Very low temperature effect
- High signal-to-noise ratio
- Temperature sensor build into sensor
- Predictable
- It is an active sensor

Disadvantages

- Relatively expensive to manufacture
- Cannot be used on 'hot' side of nuclear power plants

Silicon Resonant Sensor

Silicon resonant sensors are fabricated from a single crystal silicon using 3D semi-conductor micromachining techniques. Two "H" shaped resonators are patterned on the sensor, each operating at a high frequency output. As pressure is applied, the bridges are simultaneously stressed, one in compression and one in tension. The resulting change in resonant frequency produces a high differential output (kHz) directly proportional to the applied pressure. This simple time-based function is managed by a microprocessor.

The microprocessor can receive the digital signal directly from the sensor without having to go through an A/D converter. This improves the overall accuracy of the transmitter since, though small, there is a certain probability for error in each stage of conversion.

In a DP application, the microprocessor can also use the two frequencies to determine the Static Pressure. Therefore, this sensor can measure two different process attributes with a single sensor.

4 Transmitters



The signal coming directly from the sensor is small. This small signal would not be useful to us if we sent it any distance. The job of any transmitter is to take the sensor output, convert it to a strong standardized signal, and transmit it. **The mark of a good transmitter is to do this *quickly, accurately, and reliably.***

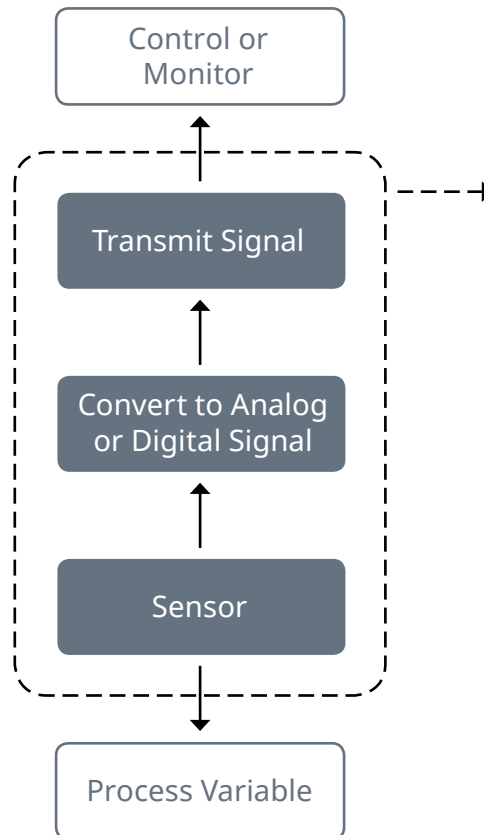

Did you know?

All transmitters perform the same task, but all transmitters are not the same. What separates them is how ***quickly, accurately, and reliably*** they perform this task.

Essential Terms to Know

Lower Range Limit (LRL): Minimum value that a sensor can measure

Upper Range Limit (URL): Maximum value that a sensor can measure

Range (URL + |LRL|): Total pressure that the sensor can measure

Lower Range Value (LRV): The lowest value that the transmitter has been adjusted to measure. This value corresponds to the 4 mA analog signal.

Upper Range Value (URV): The highest value that the transmitter has been adjusted to measure. This value corresponds to the 20 mA analog signal.

Span (URV - LRV): The difference between the URV and LRV. Sensors have a minimum span requirement that must be considered while assigning the 4 to 20 mA analog output.

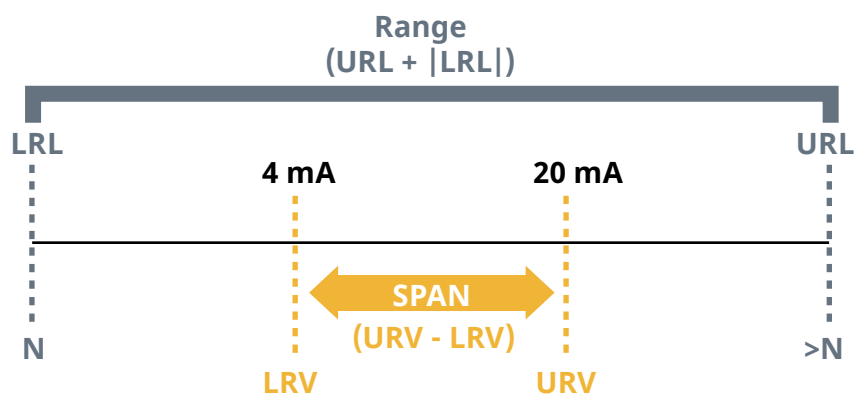

Communication Standards **5**



There are several different communication standards on the market. This section covers what type of signal the transmitter converts the sensor signal to for transmission.

Overview

Pressure transmitters typically provide analog signals, which vary to correspond to pressure variations within the process. These signals are transmitted down wiring that connects to the controller. Analog signals can be 4 to 20 mA or 1 to 5 V DC. However, the 4 to 20 mA is the most widely accepted in the process industry because they provide a safe, low current signal that is not as susceptible to noise as the 1 to 5 V DC. This allows the 4 to 20 mA signal to be used over greater distances. However, the 1 to 5 V DC uses a significantly lower amount of power. This is important in areas that may power the transmitter by alternate power sources such as solar panels or wind generators.

Transmitters that supply only the analog signal are referred to as **'dumb'** transmitters or, because of their general shape, **'stick'** transmitters. This type of transmitter offers very fast response time and is relatively inexpensive, but only supplies information on one process parameter.

'Smart' transmitters have a digital communication protocol, which operates on top of the conventional 4 to 20 mA or 1 to 5 V DC loop signal. The digital protocol preserves the present control strategies by allowing the traditional analog signal to coexist on existing two-wire loops. There are several different communications standards (protocols) that work in this way.

Other **'smart'** transmitters use a pure digital signal with no analog primary signal.

Because both of these types are digital protocols, **'smart'** pressure transmitters have a good amount of processing capability. Functions normally reserved for the controller or DCS can be accomplished at the transmitter. Additionally, **'smart'** transmitters give users both better diagnostics and more descriptive error coding.



PROTOCOL TYPES

Analog / Digital

BRAIN® Protocol:

A 4 to 20mA analog signal that corresponds to the primary variable. Analog signal has a digital signal superimposed using BRAIN® protocol. BRAIN® protocol stores the driver in the transmitter. This gives the device a plug-n-play type capability. BRAIN® is proprietary to Yokogawa.

HART® Protocol:

A 4 to 20mA analog signal that corresponds to the primary variable. Analog signal has a digital signal superimposed (via frequency shift keying) using HART® protocol. HART® protocol requires that the proper driver be loaded into the controller / monitor / DCS / communicator to communicate properly with the transmitter. HART® is the most widely used protocol for pressure transmitters.

HART® Protocol:

A 1 to 5 VDC analog signal that corresponds to the primary variable. Analog signal has a digital signal superimposed using HART® protocol. HART® protocol requires that the driver be loaded into the controller / monitor / DCS to work properly. This option has very low power consumption and is primarily with alternate power sources.



Observation

There is no industry standard or default wireless protocol. Most users prefer the 4 to 20 mA analog signal for the primary variable. HART® is the most popular digital protocol, but some use it only to set up the 4 to 20 mA analog signal. They do not take advantage of the capabilities of a 'smart' transmitter.

All Digital

FOUNDATION™ Fieldbus:

All-digital communication protocol that does not have an analog component. FOUNDATION™ Fieldbus greatly expands the capability of the transmitters but is a complex protocol that some users may find difficult to use. This protocol eliminates the D/A converter needed for the analog signal.

PROFIBUS® PA:

All-digital communication protocol that does not have an analog component. PROFIBUS® PA has a very small install base in North America. This protocol eliminates the D/A converter needed for the analog signal.

6 Key Characteristics



Remember- a good transmitter gets the measured process variable to the monitor, controller, or DCS **quickly, accurately, and reliably**. But what does that mean?

Quickly is the easiest to define for transmitters. The response time of each manufacturer's transmitters varies. However, response time depends on the measurement range selected and the diaphragm material used. Read the transmitter documentation carefully to determine the correct response time for the transmitter chosen. Some transmitters can have a response time as fast as 90 msec and as slow as 1 sec.

Accurately is defined in the Reference Accuracy of Calibrated Span. Reference accuracy includes terminal based linearity, hysteresis, and repeatability. Since transmitters have a wide range of wetted materials, fill fluids, outputs, and spans, manufacturers have defined the physical attributes of the transmitter for the reference accuracy to generate a simple number. Some manufacturers also add narrow operational conditions in an effort to improve the appearance of their specification, but a transmitter in the field rarely operates in these limited operational conditions.

Reference accuracy is expressed as \pm percentage of span.
Example: $\pm 0.055\%$ of span

Reliably is defined by the Stability specification. Stability is a measure of the degree for which a sensor's characteristics remain constant over time. Changes in stability are commonly referred to as drift. It is usually due to aging components in the transmitter. Manufacturers define not only the physical attributes of the transmitter, but also a narrow operational condition for this specification. This improves the appearance of their specification, but again, a transmitter in the field rarely operates in these limited operational conditions.

Stability is expressed as \pm percentage of URL per unit of time.
Example: $\pm 0.1\%$ of URL / 7 years.

7 Diaphragm Seals



There are applications that are not typically well-suited for pressure transmitters, such as:

- Process temperatures beyond the limits of the transmitter
- Special process connections such as sanitary connections, PMC connections, and quick disconnect for easy cleaning between batches
- Presence of solids or viscous fluids that could plug impulse lines or the transmitter
- Process is corrosive to the wetted materials of the transmitter
- Replacement of inefficient wet legs (in older facilities)

The solution for all of these conditions is to add a diaphragm seal system to the transmitter. The seal system functions as an extension of the transmitter, but isolates it from the process. It also allows for the adoptions of special process connections.

Diaphragm seal systems use the principle of hydraulics to mechanically transfer the force applied at the process diaphragm to the transmitter diaphragm.

Need More Information?



Differential pressure level measurement has an enemy - temperature. Temperature can have a negative effect on the accuracy of level measurement. This article covers why temperature has this effect and how it can be reduced.

[Download](#)

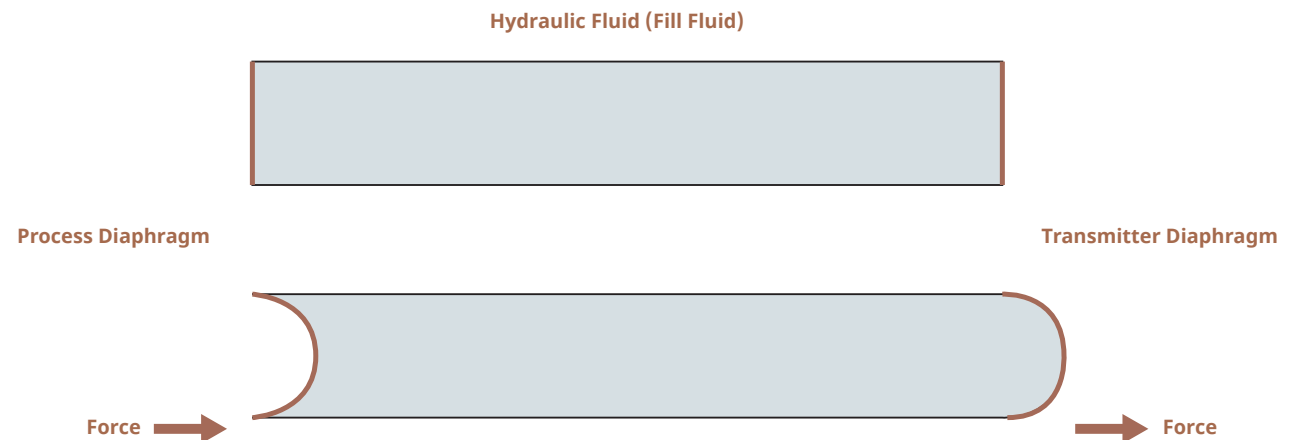

The fill fluid is a non-compressible liquid that is compatible with process temperature and pressure. Basically, the process pressure is transmitted to the transmitter via the fill fluid.

A **diaphragm seal system** consists of the transmitter, a process connection, and a capillary connecting the two.

Diaphragm Seal System

Transmitter:

The part of the system that measures and converts the measured variable to a signal to be transmitted.

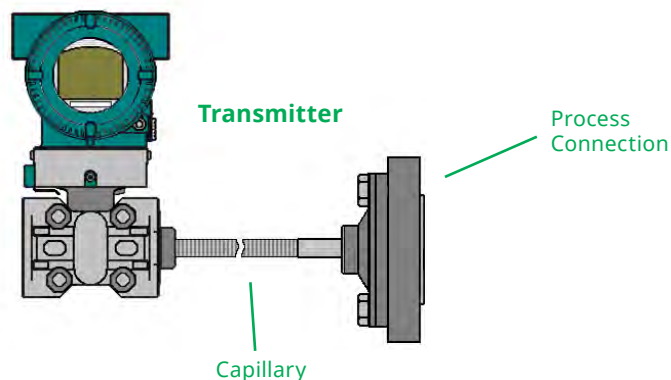

Capillary:

The capillary connects the diaphragm seal to the transmitter and contains the fill fluid. There are two different ways to connect- use of a short rigid pipe (referred to as direct mount or close coupled) or a flexible tube. The flexible tube is armored and may or may not be coated in PVC. The term capillary usually refers to the flexible tubing method of attachment. The capillaries are used to move the transmitter away from high process temperatures or to more conveniently locate the transmitter if the process connections are difficult to get to. The length of the capillary can increase the temperature-induced error in the system. To minimize, always use the shortest capillary required.

Process Connection:

The part that includes the diaphragm seal. The process connection is what is in contact with the process and is available in a host of sizes, types, flange ratings, and wetted materials. This part solves the issues associated with the applications previously mentioned. The process connection can be a sanitary type, a PMC seal, or quick disconnect. Use a wetted material that can withstand a corrosive process or prevent clogging in applications with solids.

With all diaphragm seal applications, you want to use the smallest diameter diaphragm that can measure the span required. The smaller the surface area of the diaphragm, the more temperature-induced error will be contributed to the system. However, diaphragm seal technology does have a lower limit it can measure, so you need to balance the two conditions. The chart below is a guideline of recommended sizes for different measurement spans. There are design differences between seal types or even manufacturers that can change these limits.

Transmitter Span	Suggested Diaphragm Size
10 to 100 in H ₂ O	≥ 3 inch
100 to 1,000 in H ₂ O	≥ 2.4 inch
30 to 200 psi	≥ 2 inch
200 to 1,000 psi	≥ 1 inch



Common Types of Diaphragm Seals

Although there are several types of diaphragm seals available on the market, flanged, pancake, extended flanged, and sanitary are the most common.



Flanged



Pancake



Extended Flanged



Sanitary



Performance

Some users make the assumption that the accuracy and response time for the entire system are the same as the transmitter used in the system. The accuracy of the entire system is equal to the transmitter accuracy plus the accuracy of the capillary and diaphragm seal. Therefore, the accuracy of the entire system is less than the individual transmitter. The same is for the response time. The system response time is equal to the transmitter response time plus the response time of the capillary/diaphragm seal.

System Accuracy = Transmitter Accuracy + Capillary/Diaphragm Seal Accuracy

System Response Time = Transmitter Response + Capillary/Diaphragm Response

Summary

Advantages

- Extends the capabilities of the transmitter by shielding it from high temperature processes
- Increases mounting flexibility with a host of different process connections available
- Reduces maintenance by eliminating impulse lines that may get plugged or wet legs
- Extends the life of the transmitter by shielding it from corrosive processes

Limitations

- Temperature-induced errors from wide changes in ambient temperature
- Small span cannot be measured (spans ≤ 10 in H_2O)
- Increased response time
- Decreased accuracy



Closer Look

The wetted materials on a diaphragm seal system are located on the seal, not the transmitter. If a material certificate is requested, order the one covering the seal. There is no need to order the certificate for the transmitter because it no longer has any wetted materials.

If a calibration certificate is requested, make sure you order the certificate that covers the entire system, not just the transmitter.

Thank You for Reading This Ebook!

For more information on Yokogawa's pressure products, please contact us for a free consultation.

Pressure Handbook

A Basic Guide to Understanding Pressure

Author

Lee Hamlett

Product Manager, Pressure Products

ABOUT YOKOGAWA

Yokogawa's global network of 92 companies spans 59 countries. Founded in 1915, the US \$3.7 billion company engages in cutting-edge research and innovation. Yokogawa is active in the industrial automation and control (IA), test and measurement, aviation, and other business segments.

The IA segment plays a vital role in a wide range of industries including oil, chemicals, natural gas, power, iron and steel, pulp and paper, pharmaceuticals, and food. For more information about Yokogawa, please visit our website www.yokogawa.com.



CLICK HERE

For Your Free Consultation